

2025

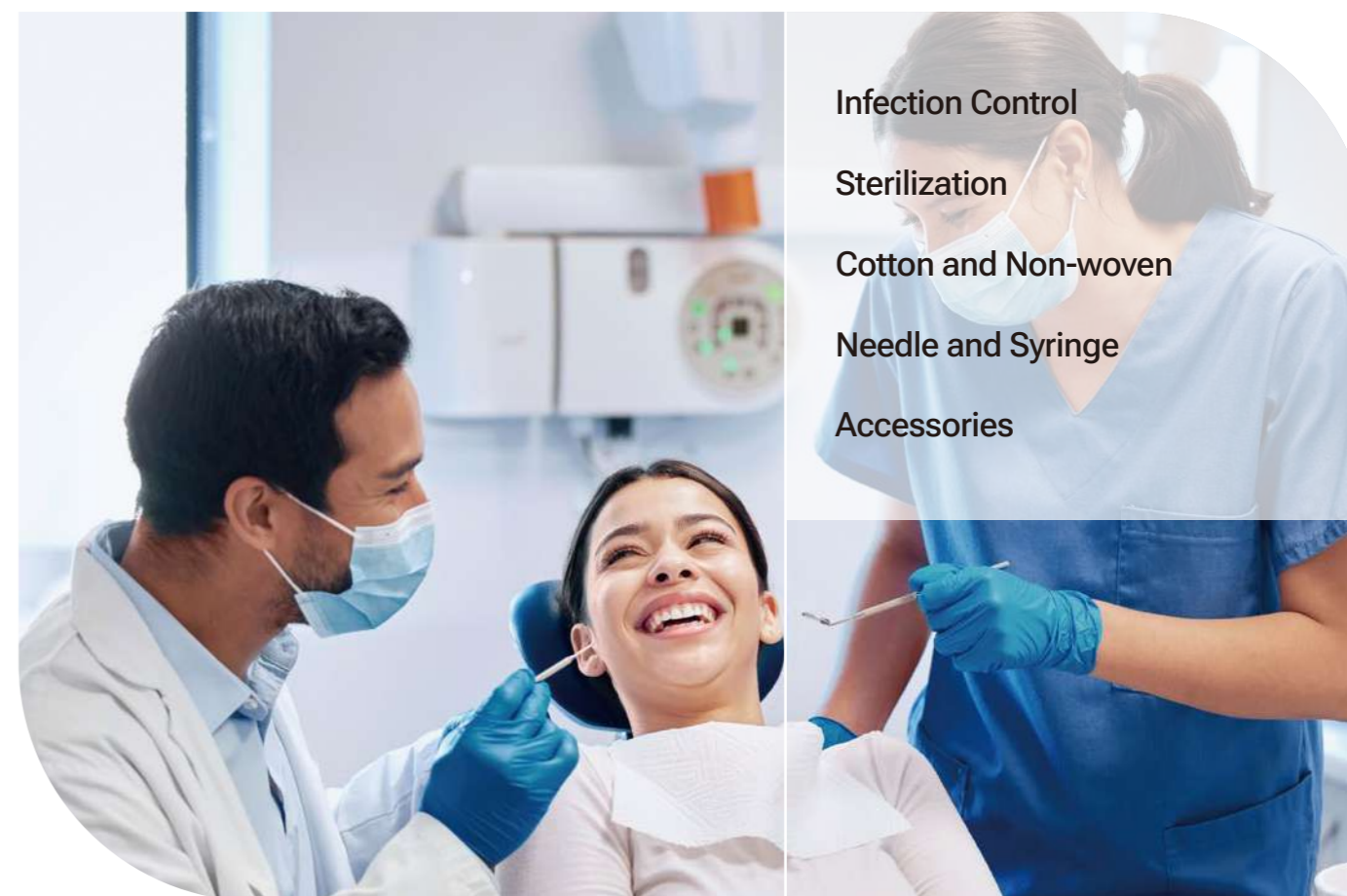

Infection Control  
Sterilization  
Cotton and Non-woven  
Needle and Syringe  
Accessories

**SHANGHAI DOCHEM INDUSTRIES CO., LTD.**

Add. 2nd Floor, Business Building, Lane 359, Shitai Road, Shanghai 200444, China  
Tel. +86-21 6277 4584 / 6277 9265  
+86-21 6277 9367  
Fax +86-21 6277 6590  
E-mail [info@dochem.biz](mailto:info@dochem.biz) / [dochem@sh163.net](mailto:dochem@sh163.net)  
Web [www.dochem.biz](http://www.dochem.biz)



**CATALOGUE**

Manufacturer of  
Dental Disposable Products

## About Us

### Value return

Ever since it was found, Dochem has understood that our business depends on our customers. Quality and service have always been the core of our philosophy. The trustworthy quality of our products, along with the comprehensive pre-sale and after-sale supports we offer instill full confidence in our merchandise. The competitive pricing strategy always keeps our customers' profitability as the top priority.

### Experience and innovation

Dochem is a professional manufacturer and supplier of dental and medical disposables. Equipped with efficient producing facilities, strict testing procedures, professional staff and flexible trade models, we ensure that all of our products are manufactured in compliance with international standards and meet diverse needs of our customers.

### Work with us

When you choose Dochem, you're partnering with one of the most trustworthy qualified suppliers certified by FDA, CE, and ISO 13485, etc. We are committed to enhancing the product selection and quality of our service year by year, such as shortening lead time and assist in lowering inventory, aiming to provide continuous and increased profits for our clients.



Shanghai Dochem Industries Co., Ltd. has applied for legal protection for the Logos and Designs, the whole or any part of this catalog may not be copied without permission. Dochem reserves the right to make any improvement or change on design without advance notice.

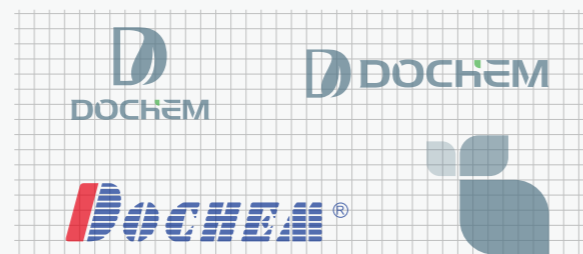

## CONTENTS



### COTTON/SPONGE

- 01 cotton roll, cotton pellet
- 02 cotton roll dispenser, holder, clip
- 03 gauze/non-woven sponge, holder



### INFECTION CONTROL

- 04-05 face mask
- 05 shield
- 06 gown, shoe cover, cap
- 07 glasses
- 08-09 dental bib, apron, bib clip



### STERILIZATION

- 10 sterilization pouch and reel
- 11 indicator, sealing machine



### BARRIER/SLEEVE/COVER

- 12-15 plastic sleeves/sheaths/covers
- 16 headrest cover, barrier film and dispenser



### EVACUATOR/SUCTION/ASPIRATION

- 17 saliva ejector
- 18-19 suction tip, HVE tip, adapter



### NEEDLE/SYRINGE/TIP

- 20 needle
- 21 needle tip, syringe cap
- 22 syringe
- 23 air/water syringe tip



### BRUSH/APPLICATOR AND ACCESSORIES

- 24 micro applicator, dispenser
- 25 brush, sticky applicator
- 26 mixing well/ring, dish, mortar and pestle
- 27-28 prophyl cup/brush



### EXAMINATION & TREATMENT

- 29 mouth mirror
- 30-31 probe, tweezer, kit
- 32 oral surgery drape kit
- 33 blade, suture with needle
- 34 rubber dam frame, shield
- 35 tray, tray cover
- 36 cup, cup dispenser
- 37-39 mouth opener, cheek retractor
- 70 articulating paper, wedge



### ENDODONTICS

- 41-42 GP, PP, endo container
- 43-44 endo file
- 45 endo foam, cassette, ruler
- 46 barbed broach, screw post, pesso reamer, gates drill
- 47-48 endo disinfection box, ruler
- 49 fiber post



### IMPRESSION & ACCESSORIES

- 50-52 impression tray
- 53 fluoride foam tray
- 54 spatula, mixing bowl
- 55 mixing pad, activator, applier, amalgam carrier, dispenser gun



### X-RAY/DIGITAL & ACCESSORIES

- 56 barrier envelope, protective cover paper, digital imaging plate
- 57 X-ray film, film mounts, holder
- 58 film holding system, lead apron/collar



### DENTURE BOX & CONTAINER

- 59 denture box, retainer box
- 60 denture bath box/case, denture box with basket
- 61 baby tooth box, denture/retainer box with mirror



### INSTRUMENT BLOCK/HOLDER/CASSETTE

- 62 bur block, bur dispenser/holder
- 63 disinfection box, bur block/holder
- 64 instrument sterilization cassette



### ORTHODONTICS

- 65 orthodontic supplies
- 66 aligner chewie/seater/remover, elastic placer, handle mirror



### LAB. PRODUCTS

- 67 ortho model, articulator, turnover box, alcohol lamp



### COTTON ROLLS

- Highly absorbent pure cotton
- Flexibility, conforms easily, maintains its shape when wet
- No cellulose or rayon fibers
- No metal, glass, grease
- Will not adhere to mucous membranes
- Well-packed for protection



#### Bag Package

ref.#	description	pcs/bag	bags/ctn
1A0001	#1 0.8cm x 3.8cm	1000	20
1A0002	#1 0.8cm x 3.8cm	2000	12
1A0003	#1 0.8cm x 3.8cm	750	40
1A0011	#2 1.0cm x 3.8cm	1000	20
1A0012	#2 1.0cm x 3.8cm	2000	12
1A0013	#2 1.0cm x 3.8cm	600	40
1A0015	#2 1.0cm x 3.8cm	500	48
1A0021	#3 1.2cm x 3.8cm	1000	20

#### Box Package

ref.#	description	pcs/box	boxes/ctn
1A0000	#1 0.8cm x 3.8cm	2000	12
1A0010	#2 1.0cm x 3.8cm	2000	12
1A0014	#2 1.0cm x 3.8cm	600	40
1A0020	#3 1.2cm x 3.8cm	2000	6

Order Notice:  
More package types are available upon requests

### DENTAL PELLETS

- Made of pure cotton, all natural and biodegradable
- Great absorption to apply medicines and dry cavities
- Allows the dentist to complete a painless, hygienic and economical application

#### Usages:

- Root canals
- Temporary endo access
- Implants, cover hex screw
- Irrigating solution
- Temporarily as a filler

ref.#	description	bucket/box	boxes/ctn
2A0030	#0, Dia.9.0 mm, 10g/bucket	24	8
2A0031	#1, Dia.7.0 mm, 10g/bucket	24	8
2A0032	#2, Dia.5.5 mm, 10g/bucket	24	8
2A0033	#3, Dia.4.0 mm, 4g/bucket	50	8
2A0034	#4, Dia.3.2 mm, 4g/bucket	50	8
2A0035	#5, Dia.2.4 mm, 4g/bucket	50	8



### COTTON ROLL DISPENSER

- Flip-up top for easy loading
- Holds up to 40 rolls, for size #2
- Non-skid base for easy dispensing
- Heavy duty, positive aseptic barrier

ref.#	description	pc/box	boxes/ctn
1A0040	Press type	1	50
1A0041	Drawer type	1	40
1A0046	Rolling type	1	30

Colors: Blue, beige, green, pink, purple, black, transparent, etc.



### COTTON ROLL HOLDING BOX

- Made of durable plastic, autoclavable
- Stainless steel pins embedded in the bottom, holds cotton roll in near ward position
- With lid, easy to refill and protect the cotton roll
- Size: Dia. 3-1/5" x H 2-1/5"

ref.#	description
1A0050-G	Gray
1A0050-GN	Green
1A0050-B	Blue
1A0050-Y	Yellow

Packing: 1 pc/box, 100 boxes/ctn



### COTTON ROLL HOLDER CLIP

- Made of high quality plastic
- Disposable and works with cotton rolls to isolate teeth

Packing:  
100 pcs/bag, 40 bags/ctn

Ref.1A0060



### COTTON PELLETS DISPENSER

- White, for small pellets, spring loaded, pushes pellets to the surface
- Size: 1-7/8" x 1-7/8" x 2-1/16", 25 dispensing holes

Packing: 10 pcs/box, 50 boxes/ctn

Ref.1A0066





### ALL-GAUZE SPONGES

Non-sterile, premium pure cotton



- Increase patient more comfort
- No chemical additives
- For multipurpose applications
- Made of natural pure cotton
- Paper sleeve packing, box packing is also available



#### Mesh: 19 x 9

ref.#	description	pcs/sleeve	sleeves/ctn
1A0160	2" x 2" (5cm x 5cm)	200	25
1A0161	2" x 2" (5cm x 5cm)	200	40
1A0164	4" x 4" (10cm x 10cm)	200	20
1A0165	4" x 4" (10cm x 10cm)	200	10

#### Mesh: 19 x 15

ref.#	description	pcs/sleeve	sleeves/ctn
1A0170	2" x 2" (5cm x 5cm)	200	25
1A0172	3" x 3" (7.5cm x 7.5cm)	200	20
1A0174	4" x 4" (10cm x 10cm)	200	20

### GAUZE SPONGE HOLDERS

- Keep sponge in the position ready for use
- Weighted bottom, cover included
- Steam autoclavable and chemiclavable
- Suits for size 2" x 2" (5cm x 5cm) gauze

Packing: 1 pc/box, 100 boxes/ctn



- 1A0210 Yellow
- 1A0211 Blue
- 1A0212 Green
- 1A0213 Beige
- 1A0214 White

### SAFE NON-WOVEN SWAB (SPONGE)

Non-sterile, highly absorbent non-woven

- Premium quality, excellent absorption capacity, no chemical whiteners added
- Increased patient comfort with extra soft feeling, adaptable and non-irritating, even if a certain friction is required for wound cleansing
- Being easily handled, ready for use, non-adherent
- Being ideal for wound cleansing, coverage, isolation, protection from lesions
- Paper sleeve packing, box packing is also available



ref.#	description	pcs/sleeve	sleeves/ctn
1A1600	30 gsm, 2" x 2" (5cm x 5cm)	200	50
1A1601	30 gsm, 3" x 3" (7.5cm x 7.5cm)	200	50
1A1602	30 gsm, 4" x 4" (10cm x 10cm)	200	40
1A1604	40 gsm, 2" x 2" (5cm x 5cm)	200	50
1A1605	40 gsm, 3" x 3" (7.5cm x 7.5cm)	200	50
1A1606	40 gsm, 4" x 4" (10cm x 10cm)	200	40

### COTTON-FILLED EXODONTIA SPONGES

Non-sterile, natural pure cotton

- Save time with economical multipurpose sponge
- Increased absorbency, no chemical additive
- With pure cotton-fiber filling



ref.#	description	pcs/sleeve	sleeves/ctn
1A0100	2" x 2" (5cm x 5cm) 8-ply	200	25

# FACE Disposable MASK



High Filtration Level



Skin-friendly Layers



Comfortable Flat Earloop



Wide and Light Nose Strip



Assorted Colors



1A3100



1A3101



1A3102



1A3103



1A3104

Packing: 50 pcs/box, 40 boxes/carton

#### Standards & Levels

- EN14683:2019
- TYPE IIR
- Medical Use
- ASTM Level 2

#### ASTM specification

- BFE (bacterial filtration efficiency): ≥98%
- PFE (particulate filtration efficiency): ≥98%
- Fluid resistance(measured in mm Hg): 120
- Delta P (differential pressure): <5.0
- Flame spread: Class 1



### TOPSAFE SURGICAL TIE-ON FACE MASK

#### Premium Elite

- BFE: ≥98% PFE: ≥98%
  - Resistance to penetration by synthetic blood (mmHG): 120
  - Flame spread: Class I
- Packing: 50 pcs/box, 40 boxes/ctn

- 1A3130 Blue
- 1A3133 Pink
- 1A3131 Green
- 1A3134 Yellow
- 1A3132 White



### TOPSAFE PRO-SHIELD MASK

- Two-in-One protection with combination face mask and eye shield
  - Fluid resistant, added protection with unique shingle pleat design, high bacterial filtration
  - Optically clear shield, latex-free
  - Both earloop and tie-on mask are available
- Packing: 50 pcs/box, 20 boxes/ctn

ref.#	description
1A3150	Fog-Free, blue mask
1A3152	Fog-Free, green mask



### FULL FACE SHIELD

- Fog-free design, disposable shield provides full-face protection
  - Vented sponge cushion absorbs sweat 100% optically clear, plastic barrier
  - Comfortable non-latex band eliminates pressure points
  - Fits over glasses and face masks
- Packing: 10 pcs/bag, 20 bags/ctn



Ref. 1A3310



### SAFETY EYEWEAR

- Provides extra safety, multiple use and versatile
  - Used in conjunction with ear-loop mask will provide complete protection from sprays and debris to facial area.
- Packing: 50 pcs/box, 10 boxes/ctn



Ref. 1A3300



### EYEWEAR FACE SHIELD

- Eyes frame designed fits most face

ref.#	description
1A3314	Set: 1 frame + 1 lens
1A3314-E	Frame
1A3314-S	Lens
1A3314-M	Set: 1 frame + 10 lens



Ref. 1A3314

### TIE-BACK ISOLATION GOWNS

- Added protection against cross-contamination
  - Comfortable fit with cuffs, neck ties, and back ties
  - Fluid resistant, non-irritating
  - Colors available: blue, green, yellow, white
- Packing: 10 pcs/bag, 10 bags/ctn

#### Material Weight (Non-woven) : 38 GSM

More choices of material available: 30 gsm, 40 gsm, 50 gsm, etc.

ref.#	description
1A2791	Regular/small size, <b>knit cuff</b>
1A2793	Medium size, <b>knit cuff</b>
1A2795	Large size, <b>knit cuff</b>
1A2790	Regular/small size, elastic cuff
1A2792	Medium size, elastic cuff
1A2794	Large size, elastic cuff



### LAB GOWNS

- Protects against cross-contamination
  - Non-woven, increased breathability
  - Fluid resistant, non-irritating
  - Pocket design front side
- Packing: 10 pcs/bag, 5 bags/ctn

#### Material Weight (Non-woven) : 38 GSM

More choices of material available: 30 gsm, 40 gsm, 50 gsm, etc.

ref.#	description
1A2740	Small, Elastic Cuff
1A2741	Small, Knit Cuff
1A2742	Medium, Elastic Cuff
1A2743	Medium, Knit Cuff
1A2744	Large, Elastic Cuff
1A2745	Large, Knit Cuff
1A2746	X-Large, Elastic Cuff
1A2747	X-Large, Knit Cuff



### SHOE COVER

- Fluid repellent material, protect the environment
  - Easy to use with elastic opening, quickly slip on and remove
  - Blue color
- Packing: 100 pcs/bag, 20 bags/ctn



ref.#	description
1A2720	Non-woven, regular size
1A2726	Non-woven, premier, skid-proof, regular size
1A2728	PE material, regular size
1A2729	PE material, X-large size
1A2730	CPE material, skid-proof, regular size

### BOUFFANT CAP

- Made of fluid repellent non-woven
- Comfortable and breathable
- Latex-free elastic headband

Packing: 100 pcs/bag, 20 bags/ctn



ref.#	description
1A2700	18"(46cm), white
1A2701	18"(46cm), green
1A2702	18"(46cm), blue
1A2703	18"(46cm), pink
1A2704	21"(51cm), white
1A2705	21"(51cm), green
1A2706	21"(51cm), blue
1A2707	21"(51cm), pink

## HIGH IMPACT RESISTANT SAFETY GLASSES

### MOTOR TYPE/FIXED LEG

- Polycarbonate, comfortable, good ventilate side
- Spectacle frame and lens are integrated designed
- No metal accessories, comfortable for wearers
- Broad vision and with good side vision
- UV400 protection, non-fogging is optional



ref.#	description
1A3330	Clear lens and leg
1A3331	Yellow lens and leg
1A3332	Black lens and leg
1A3333	Orange lens and leg
1A3334	Red lens and leg

**Individual box packing:**  
1 pc/box, 100 boxes/ctn

**Large box loose packing:**  
10 pcs/box, 20 boxes/ctn

### LEG ADJUSTABLE

- Polycarbonate, distortion free lens with side shields
- Light weight, comfortable to wear, with complete side and brow protection
- Adjustable temple length settings in 4 different positions with integrated stop lock
- Maximum UV 400 Protection
- Spectacles have inclination adjustments



ref.#	description
1A3340	Clear lens, blue leg
1A3341	Red lens, yellow leg
1A3342	Yellow lens, black leg
1A3343	Black lens, black leg
1A3344	Green lens, red leg

**Individual box packing:**  
1 pc/box, 100 boxes/ctn

**Large box loose packing:**  
10 pcs/box, 20 boxes/ctn

## Dental Bibs



- Maximum protection with horizontal embossed pattern and a unique water repellent edge
- Increased strength and tear resistance with plastic backing for additional clothing protection
- Size: 13" x 18" (33cm x 45.5cm)
- Multi-layers:
  - 2-ply paper + 1-ply poly
  - 1-ply paper + 1-ply poly
  - 3-ply paper + 1-ply poly
- Packing: 500 pcs/ctn



MULTI-LAYER PROCESS



FULLY LIQUID ABSORPTION



STRONG WATER PROOF

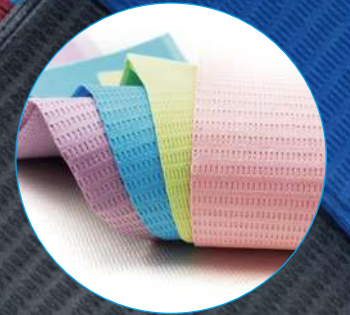

### Colors of 2-ply paper + 1-ply poly

■ 1A4200 Blue	■ 1A4203 Yellow	■ 1A4206 Pink	■ 1A4209 Wine Red
□ 1A4201 White	■ 1A4204 Lavender	■ 1A4207 Orange	■ 1A4210 Black
■ 1A4202 Green	■ 1A4205 Dark Green	■ 1A4208 Dark Blue	■ 1A4200-M21 Mixing Colors

## Wide-plus Dental Bibs

### CHEQUER PATTERN

- Special embossed pattern design, premier touch feeling
- Super protection with 3-ply paper plus 1-ply poly embossed
- Two sizes available: regular and half



ref.#	description	pcs/ctn
1A4254	White, regular size: 13"x18"(33cm x 45.5cm)	500
1A4254-B	White, half size: 13"x9"(33cm x 23cm)	1000
1A4255	Blue, regular size: 13"x18"(33cm x 45.5cm)	500
1A4255-B	Blue, half size: 13"x9"(33cm x 23cm)	1000



**TIE BIBS**

- 2 ply paper + 1 ply poly
- U-style collar
- With tough tie
- Size: 45cm x 37cm
- Packing: 500 pcs/ctn

Ref. 1A4230-TB3

**DENTAL BIBS/APRON** Roll type

- 1 ply paper + 1 ply poly
- Roll type for saving the storage space
- Multi-use: general examines, surgery, cleaning, etc.
- U-style collar with self-tie
- Size: 50 cm x 60 cm



ref.#	description	sheets/roll	rolls/ctn
1A4266-B	Blue color	80	6
1A4266-W	White color	80	6
1A4266-G	Green color	80	6
1A4266-P	Pink color	80	6

**DENTAL APRON**

- 2 ply paper + 1 ply poly (strengthen material)
- Ideal for dental, medical, and home use, especially for elderly care
- Wide self-tie
- With **POCKET** in the bottom
- Size: 40cm x 52cm
- Packing: 500 pcs/ctn

Ref. 1A4400 Blue

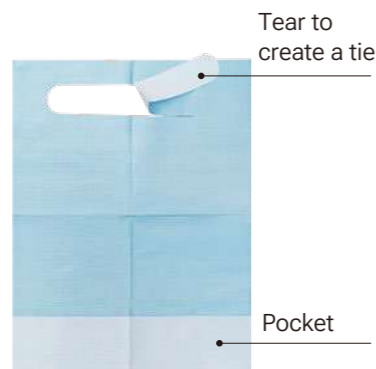

**CLIPS FOR BIBS**



**1A4406**

- Autoclavable
- Wide neck side
- Metal clip + silicone chain
- Assorted colors



**1A4302**

- Bib-lover, logo printed
- Metal clip + silicone spring chain
- Chain colors: Blue, white, and red



**1A4303**

- Helix string,
- Metal clip + silicone chain

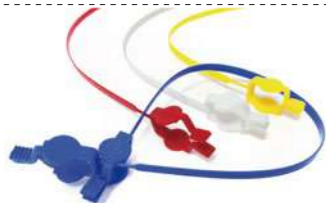

**1A4300**

- Plastic clip + plastic chain
- Packing: 20 pcs/bag, 40 bags/ctn



**1A4301**

- Metal clip + metal ball chain

# STERILIZATION

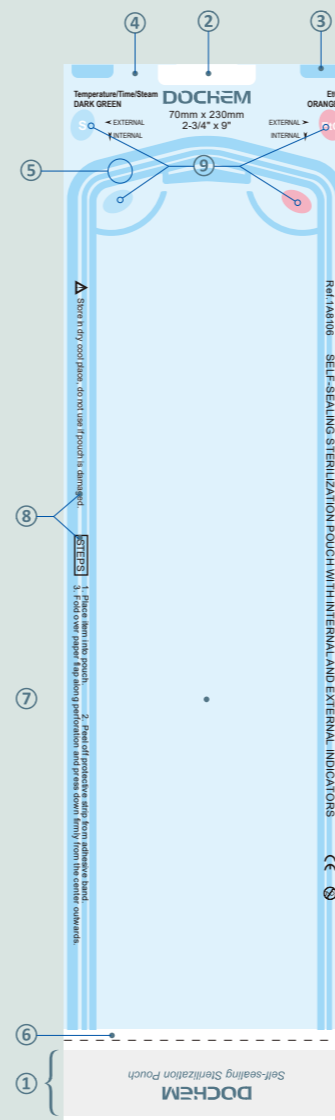

- 1 WIDE SELF-SEAL ADHESIVE STRIP**  
Ensures reliable closing without using the sealing machine
- 2 THUMB NOTCH**  
Assures pouch opened easily
- 3 WIDE SAFETY SEALS**  
Resist collection of dust, prevents corners from curling
- 4 COMPLETE PAPER-FILM SEPARATION**  
High grade materials to ensure clean and complete separation of paper and film
- 5 TRIPLE SEAL LINES**  
Enhanced three separate heat sealed rails secure edges from separation or tearing by instruments
- 6 MEDICAL GRADE PAPER**  
Meets or exceeds medical sterilization pouch standards
- 7 TRANSPARENT FILM**  
Allows easy identification of the items inside
- 8 CLEAR PRINTINGS**  
All prints are placed outside of the filling space which eliminates the possibility of paint contact with items in the package
- 9 PROCESS INDICATORS**  
Indicator color changes with STEAM or EO sterilization agent **the indicators are both internal and external**



**TOPSTERI SELF-SEALING STERILIZATION POUCHES**

ref.#	description	pcs/box	boxes/ctn
1A8100	2-1/4" x 4" (57mm x 100mm)	200	60
1A8101	3-1/2" x 9" (90mm x 230mm)	200	20
1A8102	5-1/3" x 10" (135mm x 255mm)	200	15
1A8103	7-1/2" x 13" (190mm x 330mm)	200	7
1A8104	10" x 14-1/2" (250mm x 370mm)	200	5
1A8105	12" x 15" (305mm x 380mm)	200	5
1A8106	2-3/4" x 9" (70mm x 230mm)	200	25
1A8107	3-1/2" x 5-1/4" (90mm x 135mm)	200	30

Other sizes are available.

**INTERNAL AND EXTERNAL INDICATORS**

**TOPSTERI HEAT-SEALING FLAT STERILIZATION REELS**

ref.#	description	rolls or boxes per ctn
1A8144	2" x 655' (50mm x 200m)	6
1A8140	2-1/5" x 655' (55mm x 200m)	8
1A8141	3" x 655' (75mm x 200m)	4
1A8142	4" x 655' (100mm x 200m)	5
1A8143	6" x 655' (150mm x 200m)	2
1A8145	8" x 655' (200mm x 200m)	2
1A8146	10" x 655' (250mm x 200m)	2
1A8147	12" x 655' (300mm x 200m)	2
1A8148	8" x 1150' (200mm x 350m)	1

Other sizes are available, e.g. 100 m length.



# STERILIZATION



## STEAM STERILIZATION INDICATOR TAPE

- Indicates the process of the sterilization and judges the effect of the steam sterilization
- Easily remove and tear
- Indicator printed on the tape

ref.#	description	rolls/ctn
1A8200	12.5 mm x 50 m	180
1A8201	19 mm x 50 m	117
1A8202	25 mm x 50 m	90



## EO STERILIZATION INDICATOR

- Stable indicator material
- Especially for EO sterilization course
- Indicators changing color clearly after sterilization

ref.#	description	pcs/sheet
1A8203	Indicator	40



## SEALING MACHINE

- Firm sealing, solid and durable, sharp blade
- Short sealing time, invariable temperature
- Automatic seal, adjustable temperature



Ref. 1A8215 (320 mm)

## Smart SEALING MACHINE



### • 300 MM LENGTH

ref.#	description
1A8214	Metal with paint(without temperature digital display)
1A8214-M	Stainless steel(without temperature digital display)
1A8216	Metal with paint, temperature digital display
1A8216-M	Stainless steel, temperature digital display

### • 400 MM LENGTH

ref.#	description
1A8218	Metal with paint(without temperature digital display)
1A8218-M	Stainless steel(without temperature digital display)
1A8219	Metal with paint, temperature digital display
1A8219-M	Stainless steel, temperature digital display

# Multi-use Roll Plastic Sleeves

## SIZE #2 PLASTIC SLEEVES - 18" x 2.2"

Ref.1A6300

- Disposable use only
- For air motor and air/water syringe with tubes
- Convenient dispensing with designed dispensing-slot cover
- 18" x 2.2" perforated sheets, 250 sheets/roll

## SIZE #3 PLASTIC SLEEVES - 18" x 1.8"

Ref.1A6301

- Disposable use only
- For tubing, air turbine and scaler head use
- Convenient dispensing with designed dispensing-slot cover
- 18" x 1.8" perforated sheets, 250 sheets/roll

## SIZE #4 PLASTIC SLEEVES - 11.8" x 9"

Ref.1A6305

- Disposable use only
- For headrests and X-ray heads use
- Convenient dispensing with designed dispensing-slot cover
- 11.8" x 9" perforated sheets, 250 sheets/roll

## SIZE #5 PLASTIC SLEEVES - 27.5" x 24"

Ref. 1A6311

- Disposable use only
- For half chair use
- Convenient dispensing with designed dispensing-slot cover
- 27.5" x 24" perforated sheets, 225 sheets/roll



## HANDPIECE WITH TUBING SLEEVES



- Paperboard inside, unroll the sleeve without touching the tube and handpiece, avoid infection
- LDPE material, transparent to get a clear view

ref.#	description	pcs/ctn
1A6430	20 cm x 7 cm	500
1A6430-L	240 cm x 7 cm	500





For Ref.#, please refer to page 15 >>>

# BARRIER/SLEEVE PROTECTION



SCALER HANDLE SLEEVES



HANDPIECE SLEEVES



INTRAORAL CAMERA SHEATHS



SYRINGE SLEEVES



CURING LIGHT GUIDE SLEEVES



X-RAY SENSOR SLEEVES



CHAIR SLEEVES



HEADREST COVER



X-RAY HEAD SLEEVES



OPTICAL MOUSE SHEATHS



TRAY SLEEVES



LIGHT HANDLE SLEEVES

**CURING LIGHT SLEEVES for bubble machine**

<p><b>1A6421</b></p>	<p><b>1A6426</b></p>
<p><b>1A6422</b></p>	<p><b>1A6427</b></p>

For Ref.#, please refer to page 15 >>>

**PLASTIC SLEEVES / SHEATHS / COVERS**

All the length, width and thickness, as well as material texture can be customized.

**BARRIER/SLEEVE PROTECTION**

application	ref. code & description ( 1" = 2.54cm )	packing
Plastic x-ray sensor cover	1A6400 8" x 1-5/8"	500 pcs/box, 36 boxes/ctn
	1A6401 10" x 2-1/2"	
Plastic scaler handle sleeves	1A6405 1-3/5" x 8"	500 pcs/box, 36 boxes/ctn
	1A6406 1-2/5" x 7" (with tip opening)	
Disposable intraoral camera sheaths	1A6410 9-4/5" x 2", top size: 1.0"(2.5 cm)	100 pcs/box, 36 boxes/ctn
	1A6411 10-1/5" x 2", top size: 8/9" (2.3 cm)	
Plastic curing light guide sleeves	1A6413 13-2/5" x 2-1/10"	500 pcs/box, 36 boxes/ctn
	1A6414 13-2/5" x 3-3/10"	
	1A6415 4-1/3" x 3"	
Plastic curing light sleeves for bubble machine	1A6416 4-1/3" x 3"(Diameter: 9-11 mm)	200 pcs/box, 42 boxes/ctn
	1A6417 4-7/8" x 1-1/5"(Paper, for light curing probe)	
Plastic curing light sleeves for bubble machine	1A6421 9-7/8" x 1-7/8" (straight top, width 1-1/10")	500 pcs/box, 36 boxes/ctn
	1A6422 12-2/5" x 4-1/8" (straight top, width 1-1/5")	
	1A6426 13-2/5" x 2-1/10" (curved top, width 4/5")	500 pcs/box, 20 boxes/ctn
	1A6427 13-2/5" x 3-1/3" (curved top, width 4/5")	
Plastic head rest cover	1A6500 11" X 10"	250 pcs/box, 12 boxes/ctn
	1A6501 14" X 10"	
Plastic handpiece sleeves	1A6505 1" x 8" (opening tip, length 2-3/4") for high-speed handpiece	500 pcs/box, 36 boxes/ctn
	1A6506 1-1/2" x 8" (tip cutting, length 1-4/7") for low speed, straight handpiece	
	1A6507 1-1/2" x 10" (the tip length 1-4/7")	
	1A6508 1.3" x 8" (the tip length 1-4/7")	
	1A6509 7-3/10" x 5" (for low speed, curved handpiece)	
Plastic syringe sleeves	1A6510 2-1/2" x 10" (tip cutting)	500 pcs/box, 36 boxes/ctn
	1A6511 2-1/2" x 20"	
	1A6512 2-1/2" x 10" (blue) (tip cutting)	
Plastic tray sleeves(cover)	1A6513 1-1/4" x 4-1/2"	1000 pcs/box, 50 boxes/ctn
	1A6515 11-5/8" x 16"	
Plastic x-ray head sleeves	1A6516 10-1/2" x 14"	500 pcs/box, 6 boxes/ctn
	1A6520 30" x 24"	
Plastic full/half chair sleeves	1A6521 26" x 15"	250 pcs/box, 4 boxes/ctn
	1A6522 26" x 15"	
	1A6525 Full, 29" x 80"	125 pcs/box, 3 boxes/ctn
	1A6526 Full, 48" x 56"	
	1A6527 Half, 27-1/2" x 24"	
Plastic light handle sleeves	250 pcs/box, 3 boxes/ctn	225 pcs/box, 3 boxes/ctn
	225 pcs/box, 3 boxes/ctn	
Plastic digital sensor envelopes	1A6530 Rectangle-Shape, 4" x 5-3/4"	500 pcs/box, 36 boxes/ctn
	1A6531 T-Shape, 6" x 2-9/10"	
Plastic optical mouse sheaths	1A6436 2" x 4-1/2"	300 pcs/bag, 100 bags/ctn
	1A6437 1-5/8" x 4-1/7"	
	1A6438 1-5/9" x 4-1/2"	
	1A6439 1-3/8" x 4"	

**FULL-COVER BARRIER FILM**

Size: 4" x 6" x 1200 sheets per roll

- Adhesive backing, apply to various surfaces that are difficult to clean or disinfect
- Pre-cut size 4" x 6", easy to take and mold into different shapes and sizes to fit the instruments
- Convenient design with firm dispensing stand (box packing)
- Two kinds edges: **sticky edge** and **non-sticky edge**

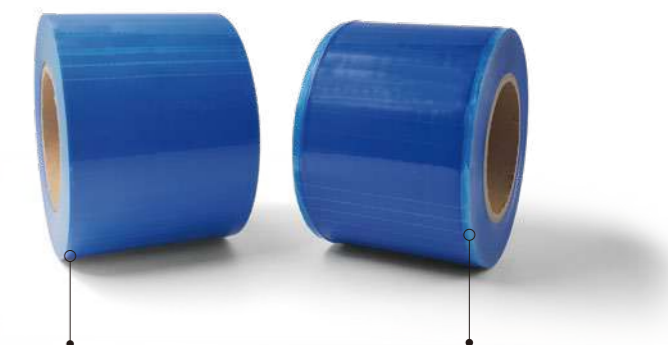

**Sticky Edge**  
idea for full covering

**Non-sticky Edge**  
easy to locate and remove  
without leaving sticky residue



Stand Dispenser

**Box Packing, with stand dispenser**

ref.#	description	roll/box	boxes/ctn
1A6535	Transparent, stick edge	1	8
1A6536	Blue, stick edge	1	8
1A6537	Transparent, non-stick edge	1	8
1A6538	Blue, non-stick edge	1	8

**Economical Packing, without box and stand dispenser**

ref.#	description	rolls/ctn
1A6535-P	Transparent, stick edge	12
1A6536-P	Blue, stick edge	12
1A6537-P	Transparent, non-stick edge	12
1A6538-P	Blue, non-stick edge	12



Ref. 1A6539  
**BARRIER FILM DISPENSER**  
1 pc/box, 12 boxes/ctn

**TISSUE/POLY HEADREST COVER**

- Film coated paper, premium material
- Easy to place and remove
- Keep the headrest clean, reducing cross-contamination
- Colors available: **white, blue, pink**

ref.#	description	pcs/bag	bag/ctn
1A4430	White, 10" x 10"(25cm x 25cm)	500	1
1A4431	White, 10" x 13"(25cm x 33cm)	500	1





## SALIVA EJECTOR

- Available in multiple **color** combinations.
- Removable tip is available.

ref.#	description
1A5100	Clear tube with blue tip
1A5101	Clear tube with clear tip
1A5114	Clear tube with green tip
1A5115	Clear tube with white tip
1A5102	White tube with white tip
1A5111	White tube with clear tip
1A5118	White tube with blue tip
1A5117	White tube with green tip
1A5103	Blue tube with clear tip
1A5108	Green tube with clear tip
1A5109	Red tube with clear tip
1A5110	Green tube with green tip
1A5123	Purple tube with clear tip



### Packing:

- 100 pcs/bag, 10 bags/ctn
- 100 pcs/bag, 20 bags/ctn
- Flexible



Durable medical grade material, provides optimal suction



Wire-reinforced structure forms any desired shape, the wire is made of non-rusting alloy, with pre-cutting spots



Soft and smooth bonded tip to avoid aspirations for maximum patient safety and comfort



Stable rounded-edge end fits most standard suction holder/valve

Ever Comfort

## EVACUATOR TIP

- Reduced splatter with ideal aspiration efficiency of 45° tip
  - Unique "S" tip for maximum patient comfort, no sharp edges
  - Straight handle allows for increased control, access to working area directly
  - More colors are available
- Packing: 100 pcs/bag, 20 bags/ctn

ref.#	description
1A5150	Non-vented, white
1A5151	Vented "S", white
1A5152	Blue, Non-vented
1A5153	Blue, Vented "S"



Vented S-Shape



Non-vented Shape



## SURGICAL ASPIRATOR TIP

- Made of sturdy medical grade material
- Special design of curved angle increased patient comfort
- Tips are designed to fit all high-volume evacuation systems
- Used for cheek retraction during procedure
- Colors can be customized

ref.#	description	pcs/bag	bags/ctn
1A5190	Blue 1/4"	25	50
1A5191	Green 1/4"	25	50
1A5192	White 1/8"	25	50
1A5193	Blue 1/16"	25	50
1A5194	Blue 3/8" orifice, vented tip	25	100



1A5191-94

## MAXCOMFORT HVE TIPS

- Premium quality, used for senior clinic or hospital
- Perfect molding, ultimate comfortable
- Autoclavable with 134 °C

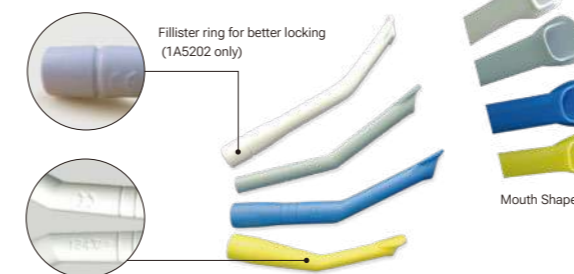

ref.#	description (L=total length, φ=end diameter)	pcs/bag
1A5202	White, heavy material, L= 160 mm, φ=15.5 mm	100
1A5204	Gray, heavy material, L= 140 mm, φ=11 mm	50
1A5206	Blue, durable light material, L= 140 mm, φ=15.5 mm	50
1A5208	Yellow, durable light material, L= 110 mm, φ=15.5 mm	50

## AUTOCLAVABLE HVE SUCTION TUBES

- European style, made of reinforced nylon
  - Curved angle, more suitable
  - 16mm, autoclavable
- Packing: 50 pcs/bag, 20 bags/ctn



ref.#	description
1A5155-AG	Standard, green
1A5155-AP	Standard, purple
1A5155-ANB	Standard, navy blue
1A5155-AY	Standard, yellow
1A5155-ADB	Standard, dark blue
1A5155-AO	Standard, orange



ref.#	description
1A5156-CG	Pedo, green
1A5156-CP	Pedo, purple
1A5156-CNB	Pedo, navy blue
1A5156-CY	Pedo, yellow
1A5156-CDB	Pedo, dark blue
1A5156-CO	Pedo, orange



### DISPOSABLE STERILE ASPIRATION TIP

- Each piece is sterilized by EO in individual pouch packing
- Made by medical class material
- Tip diameter: 2.5 mm, removable
- Each box contains 2 adapters: 11mm x 1pc + 16mm x 1pc

Packing: 1 pc/pouch,  
20 pouches/box,  
30 boxes/ctn

Ref. 1A5160



### CURVED SUCITON TIP

Packing: 50 pcs/bag,  
20 bags/ctn

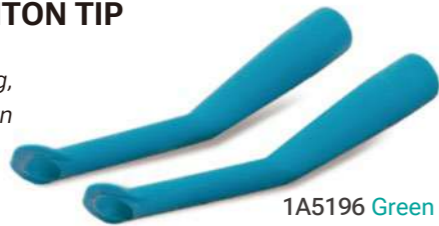

### EVACUATOR TIP SLEEVE

- Autoclavable
- Silicon material, comfort patient from sharp edges

Packing: 600 pcs/bag,  
12 bags/ctn



### SUCTION TUBE ADAPTORS

Autoclavable



ref.#	description	pcs/bag	bags/ctn
1A5210	Big adapter, reduces 16 mm to 11 mm	100	50
1A5211	Small adapter, reduces 11 mm to 6.5 mm	100	50

### TIP INSERTS / JET INSERTS / SURGE INSERTS



- 1A5230**  
Suitable to treat children
- 1A5231**  
Easy to handle, Enables the dentist to reach by holding back the tongue and the cheek
- 1A5232**  
Special for dealing with narrow operations like root fillings and implantation

ref.#	description	pcs/bag	bags/ctn
1A5230	Tip inserts	50	100
1A5231	Jet inserts	50	100
1A5232	Surge inserts	50	100

### FLEXBEND SALIVA EJECTORS

- Pre-shaping, provides tongue holder
- Packing: 100 pcs/bag,  
25 bags/ctn

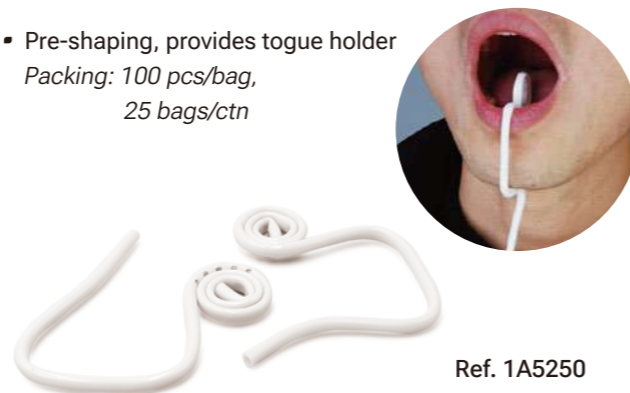

# DENTAL NEEDLE

## For Single Use

- Universal fit for both **Imperial** and **Metric** Standard
- Improved needle and hub material reduce the chance of needle breakage
- Ideal tip sharpness, provide maximum patient comfort
- Siliconised shaft for reducing resistance and pain
- Every needle is individually packed and sterilized by EO



### INDICATION LABEL SEAL PLUS HUB HEAT SEAL

Packing: 100 pcs/box, 50 boxes/ctn

ref.#	description
1A2004-B21	27G (0.40) x 21 mm
1A2004-B25	27G (0.40) x 25 mm
1A2004-B38	27G (0.40) x 38 mm
1A2005-B12	30G (0.30) x 12 mm
1A2005-B16	30G (0.30) x 16 mm
1A2005-B21	30G (0.30) x 21 mm
1A2005-B25	30G (0.30) x 25 mm
1A2005-B38	30G (0.30) x 38 mm

Other sizes are available.

### HUB HEAT SEAL ONLY WITHOUT LABEL SEAL

Packing: 100 pcs/box, 50 boxes/ctn

ref.#	description
1A2004-A21	27G (0.40) x 21 mm
1A2004-A25	27G (0.40) x 25 mm
1A2004-A38	27G (0.40) x 38 mm
1A2005-A12	30G (0.30) x 12 mm
1A2005-A16	30G (0.30) x 16 mm
1A2005-A21	30G (0.30) x 21 mm
1A2005-A25	30G (0.30) x 25 mm
1A2005-A38	30G (0.30) x 38 mm



### ASPIRATING SYRINGE BRASS MADE

- Metric thread & Imperial screw thread
- Packing: 1 pc/bag, 200 bags/ctn



ref.#	description
1A2010	1.8ml, cuspidal head
1A2011	1.8ml, hook head

**DISPOSABLE PRE-BENT NEEDLE TIPS**

- Universal Luer-lock connection
- Designed for placing etchants, sealants, cements, resins and other flowable material



Luer-lock fit



ref.#	description
1A2018	18 G, liner, <b>Pink</b>
1A2019	20 G, flow-sealant, <b>Black</b>
1A2020	21 G, <b>Green</b>
1A2021	22 G, <b>Grey</b>
1A2022	23 G, <b>Sky Blue</b>
1A2023	24 G, <b>Purple</b>
1A2024	25 G, <b>Orange</b>

**Packing**  
 - A: 20 pcs/bag, 125 bags/box, 20 boxes/ctn  
 - B: 100 pcs/bag, 25 bags/box, 20 boxes/ctn  
 - C: flexible

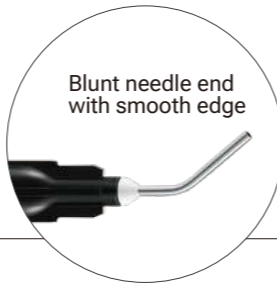

Blunt needle end with smooth edge

**DAS-TIDY IRRIGATION TIPS**

- 1" length bendable tip with universal luer lock
- Ideal for irrigation of canals, pockets and fistulas flowable material

**Slotted and side-vented**

1A2025-23	23Ga, <b>Blue</b>
1A2025-27	27Ga, <b>Grey</b>
1A2025-30	30Ga, <b>Yellow</b>

**Closed end, single side port**

1A2026-23	23Ga, <b>Blue</b>
1A2026-27	27Ga, <b>Grey</b>
1A2026-30	30Ga, <b>Yellow</b>

**Closed end, dual side ports**

1A2027-23	23Ga, <b>Blue</b>
1A2027-27	27Ga, <b>Grey</b>
1A2027-30	30Ga, <b>Yellow</b>

Slotted and side-vented    Closed end single side port    Closed end dual side ports

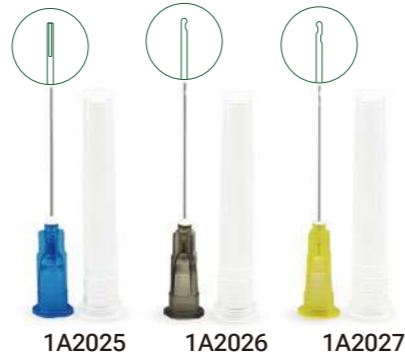

1A2025    1A2026    1A2027



See-through protecting hub



Sterile Package

Sterile Packing: 1 pc/pouch, 100 pouches/box, 50 boxes/ctn

**EZ-FLOW ENDO IRRIGATION TIPS**

- Luer lock, long and thin tip
- Great for endodontic root canal use
- More precise amount of material

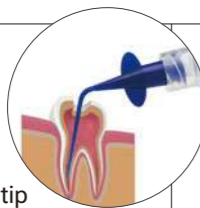

1A2060-B **Blue**  
 1A2060-T **Transparent**

**Packing:**  
 200 pcs/bag or any quantity per bag



**CLEAR-FLO PRE-BENT PLASTIC TIPS**

- Luer lock soft plastic tip
- Transparent for easy vision
- Pre-bent tip also for easy cut to adjust the flow



**Packing:**  
 100 pcs/bag



Ref. 1A2066

**SYRINGE CAPS/STOPS**

- Sturdy plastic cap, fits luer lock syringe
- Ensure a firm lock that won't pop off unintended.



1A2070, **Grey**    1A2071, **Cream**  
 1A2072, **Blue**    1A2073, **Black**

**LUER-LOCK IRRIGATION SYRINGES**

- Clear syringe with clear or white syringe plunger
- Controlled, metered delivery luer-lock syringe
- Easy, one-hand use

ref.#	description	pcs/bag	bags/ctn
1A2040	1.2ml	100	50
1A2041	3ml	100	40
1A2042	5ml	100	25
1A2044	6ml	100	25
1A2043	10ml	100	15
1A2045	12ml	100	15

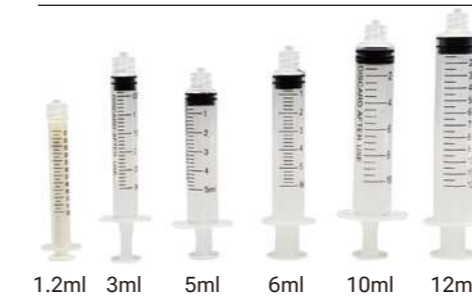

**COLOR-CODED IRRIGATION SYRINGES**

- Clear syringe, colorful plunger
- Fast and easy to organize and identify syringes
- Reduces incidence of syringe swap

ref.#	description	pcs/bag	bags/ctn
1A2042-B5	5 ml, <b>blue plunger</b>	100	25
1A2042-R5	5 ml, <b>red plunger</b>	100	25
1A2042-Y5	5 ml, <b>yellow plunger</b>	100	25
1A2043-B10	10 ml, <b>blue plunger</b>	100	15
1A2043-R10	10 ml, <b>red plunger</b>	100	15
1A2043-Y10	10 ml, <b>yellow plunger</b>	100	15



More colors of plungers are available

**LUER-LOCK CUSTOM SYRINGE WITH CAP**

ref.#	description
1A2044-WWC	1ml (0.1 scale), white plunger white cap
1A2044-WBC	1ml (0.1 scale), blue plunger blue cap

**Packing:** 100 pcs/bag, 25 bags/ctn



**CURVED TIP UTILITY SYRINGE**

- Medical glass PP material, reduce cross-contamination than metal syringes
- With 12 ml full capacity
- Rigid curved tip tapers to 1/16" for tight areas, can be cut freely to control the flow
- Piston head and pipe wall are highly adherent, provide excellent seals
- Designed for perio irrigation, impression materials, post surgical home use, fluoride and chloride treatments, etc.

**Packing:**  
 50 pcs/bag, 24 bags/ctn or 50 pcs/box, 20 boxes/ctn

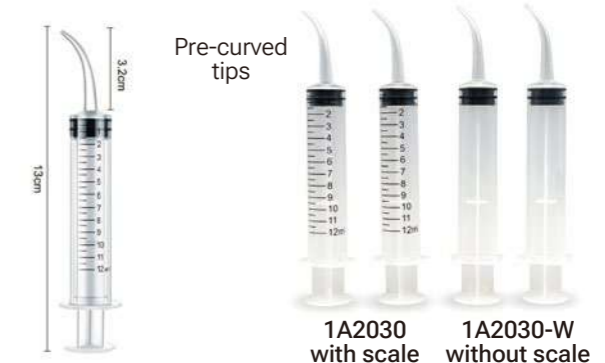

13mm  
 3.2cm  
 Pre-curved tips

1A2030 with scale    1A2030-W without scale

**DISPOSABLE BENDABLE TIP SYRINGE**

- Bend the tip to flexible angle
- Cut the tip to adjust the material flow inside

**1A2013** white color syringe, without scale  
**Packing:** 50 pcs/bag, 10 bags/ctn



**ALL BLACK IRRIGATION SYRINGE**

- Black color for both syringe and plunger
- Suitable for the light-sensitive material



ref.#	description	pcs/bag	bags/ctn
1A2049-1	1.2 ml	100	50
1A2049-3	3 ml	100	40
1A2049-5	5 ml	100	25
1A2049-12	12 ml	100	15

### DISPOSABLE AIR/WATER SYRINGE TIP

Super spray, dry air, instant separation

- Interchangeable with most metal tips, no adapter required
- Special quad air core to provide dry air
- O-ring groove lock design, avoid the leakage

Packing: 250 pcs/bag, 50 bags/ctn

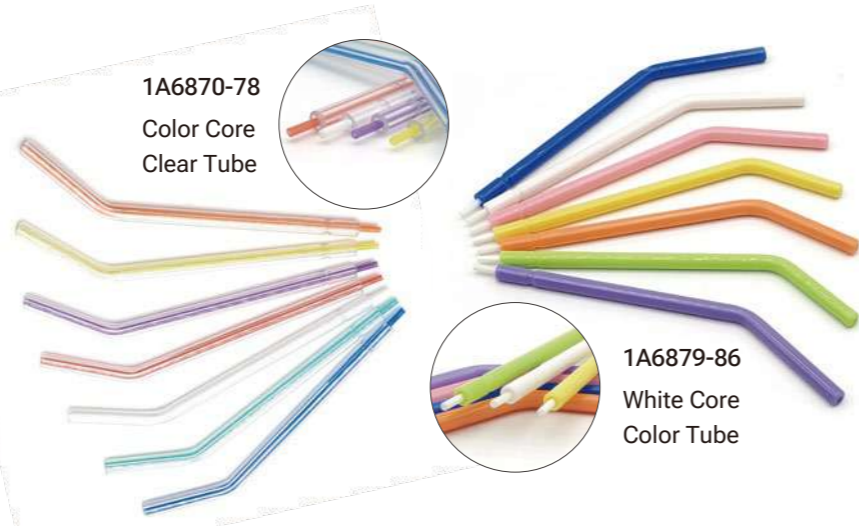
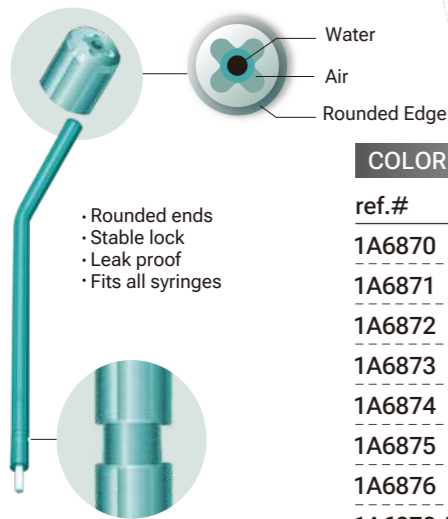

#### COLOR CORE, CLEAR TUBE

ref.#	description
1A6870	Yellow core, clear tube
1A6871	White core, clear tube
1A6872	Blue core, clear tube
1A6873	Red core, clear tube
1A6874	Orange core, clear tube
1A6875	Lavender core, clear tube
1A6876	Green core, clear tube
1A6870-M	Assorted color core, clear tube

#### WHITE CORE, COLOR TUBE

ref.#	description
1A6879	White tube, white core
1A6880	Yellow tube, white core
1A6882	Blue tube, white core
1A6883	Red tube, white core
1A6884	Orange tube, white core
1A6885	Lavender tube, white core
1A6886	Green tube, white core
1A6879-M	Assorted color tube, white core

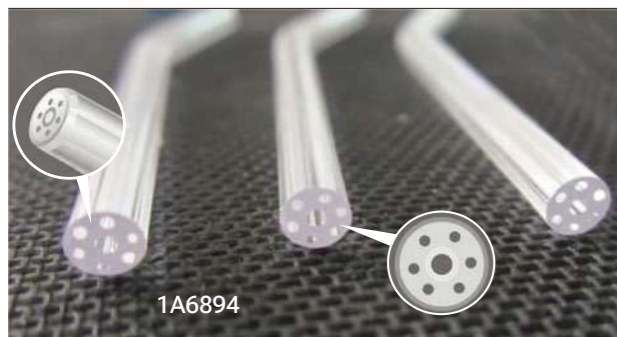

### EURO-STYLE DISPOSABLE AIR/WATER SYRINGE TIP

- Disposable, European type
  - Length: 75 mm
  - Flat tip end, with one big hole and six small holes for spraying water and air
  - Lock with the syringe without leakage
  - All transparent, without inner core
- Packing: 250 pcs/bag, 40 bags/ctn

### TOP-LOCK SAFE TIP

- White plastic outer tube, metal inner core
- Packing: 100 pcs/bag, 100 bags/ctn



### METAL AIR/WATER SYRINGE TIP

- The whole part is made of alloy
  - Fully autoclavable
  - Compatible with most of standard syringes
- Packing: 100 pcs/bag or flexible



## MICRO APPLICATOR

- Designed to deliver miniscule controlled amounts of material precisely
- Ideal for sealants, etching, bonding, cavity lining, fluoride varnishing and more
- Available in 4 head sizes by color identification
- Length 10 cm = 4"

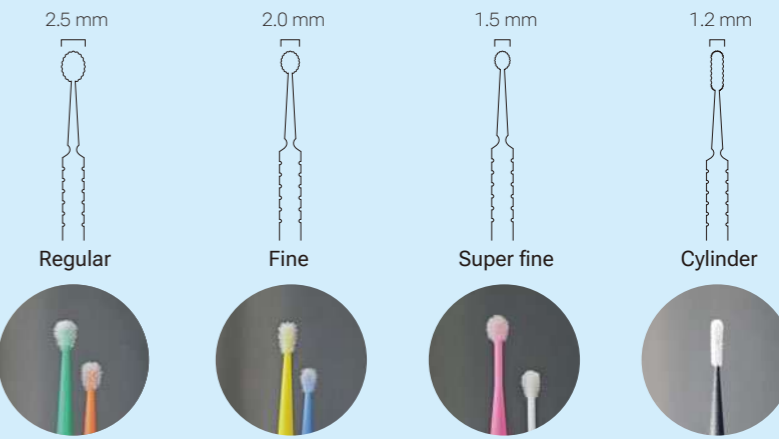

- Non-absorbent
- Flexible
- Lint-free
- Disposable



#### Flat-round Bottle



Ref.#	Description(Flat-round Bottle)
1A6541	Regular
1A6542	Fine
1A6543	Super fine
1A6544	Cylinder, extra-thin and extended

Packing: 100 pcs/bottle, 10 bottles/box, 20 boxes/ctn

#### Round Bottle



Ref.#	Description(Round Bottle)
1A6541-R	Regular
1A6542-R	Fine
1A6543-R	Super fine
1A6544-R	Cylinder, extra-thin and extended

Packing: 100 pcs/bottle, 4 bottles/box, 40 boxes/ctn

## MICRO APPLICATOR DISPENSER Press Type

- Holds most sizes of micro applicators/brushes
- Press for dispensing
- Easy accessing, can be reloaded into the new and continue to use
- Packing: 1 pc/box, 32 boxes/ctn

Ref.#	Description
1A6547-B	Blue
1A6547-G	Green
1A6547-R	Red

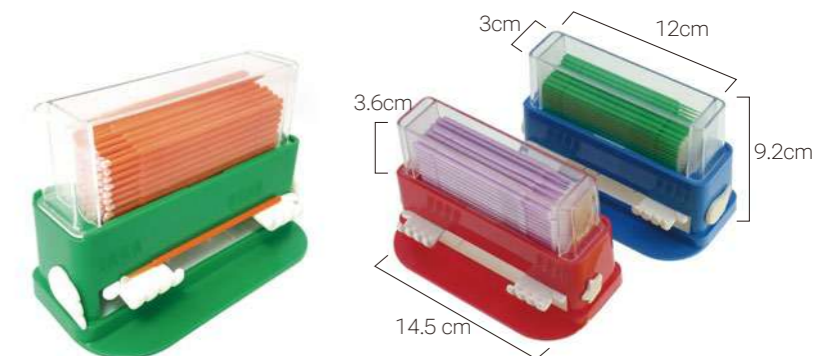

**BRUSH APPLICATORS**

- Disposable, reduce cross-contamination
  - Flexible and bendable to reach more areas
- Packing: 144 pcs/box, 100 boxes/ctn

ref.#	description
1A6550	Yellow
1A6551	Green
1A6552	Blue
1A6553	Red

**DISPOSABLE BRUSH TIP WITH HANDLE**

- Multi-purpose use
- Black color tips, can be replaced

ref.#	description	pcs/bag	bag/ctn
1A6560	Tip	100	500
1A6561	Handle with tip	100	40

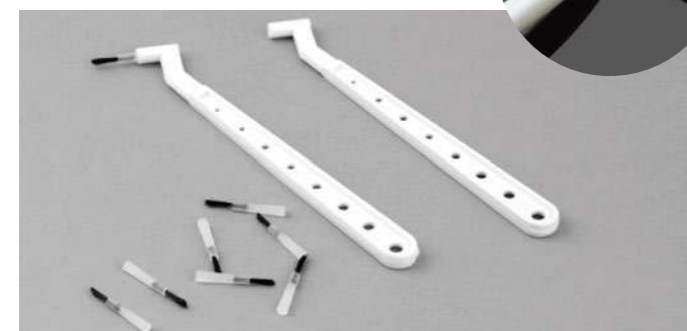
**VALUSTICK STICKY APPLICATORS**

- Disposable adhesive applicators
- Securely hold and place fragile or small objects

ref.#	description	pcs/box	boxes/ctn
1A6580	4-1/2", long, bendable	100	100

**DISPOSABLE BRUSH APPLICATORS**

- Fully disposable, non-absorbent, non-linting
  - Bendable neck to the areas difficult to reach
  - Better for placing etchants, sealer, bonding agents, cements, etc.
  - Length: 10 cm
- Packing: 100 pcs/bottle, 4 bottles/box, 40 boxes/ctn  
Colors available: blue, green, yellow, mauve, red, black



ref.#	description	ref.#	description
1A6583-B	Flat head, blue	1A6584-B	Bevel head, blue
1A6583-G	Flat head, green	1A6584-G	Bevel head, green
1A6583-Y	Flat head, yellow	1A6584-Y	Bevel head, yellow
1A6583-M	Flat head, mauve	1A6584-M	Bevel head, mauve
1A6583-BK	Flat head, black	1A6584-BK	Bevel head, black

**BOND Pro STICKY APPLICATORS**

- Strong sticky material
  - Can be bent into a variety of angles
  - Especially for taking the paste stone, inlay, high inlay crown, etc.
  - Completely one-time use
  - Self-locking packing, easy and safe to use and store
- Packing: 20 pcs/box, 120 boxes/case



Ref. 1A6581

**MIXING WELLS**

- Economical wells ideal for adhesive, activators, opaquers
  - All materials dispensed in small quantities
  - Prevent confusion when using more than one material
  - Light-weight plastic in 2-well or 4-well
- Packing: 200 pcs/box, 20 boxes/ctn



ref.#	description
1A6850	2-well
1A6851	4-well

**PLASTIC DAPPEN DISHES**

- Disposable to save time
  - Mainly for etchant, bonding and prophy materials
  - Jagged design to hold the small sticks
- Packing: 100 pcs/box, 20 boxes/ctn

ref.#	description
1A6860	Yellow
1A6861	White
1A6862	Blue
1A6863	Red

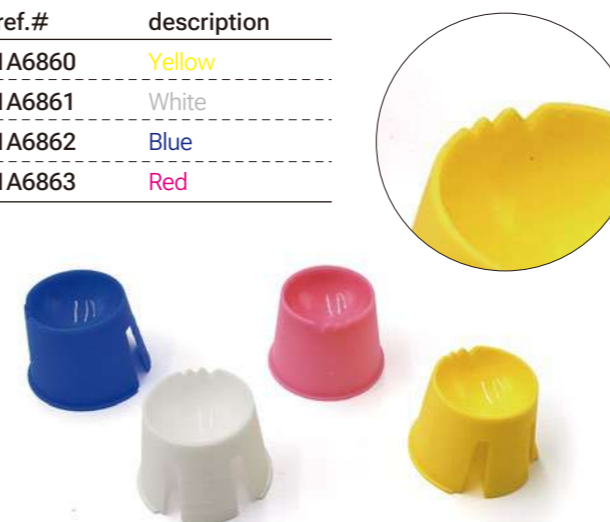
**MORTAR AND PESTLE**

- Made of sturdy glass
  - Specially designed for mixing alloy with mercury
  - Can also be used in general laboratory applications
  - Each box has 2 sets, 1 set includes 1 pc of Mortar + 1 pc of Pestle
- Packing: 2 sets/box, 40 boxes/ctn



1A6714

**GLASS DAPPEN DISHES**

- Made of thick and sturdy glass
- Stable resistance to liquid corrosion
- Smooth surface, easy to clean
- Different colors for easy identification of inside substances

Assorted colors packing: 12 pcs/box, 30 boxes/ctn



1A6715

**DISPOSABLE MIXING RINGS**

- Made of high quality ABS plastic
  - Mainly for prophy, endo use
  - Assorted colors each bag
- Packing: 200 pcs/bag, 30 bags/ctn

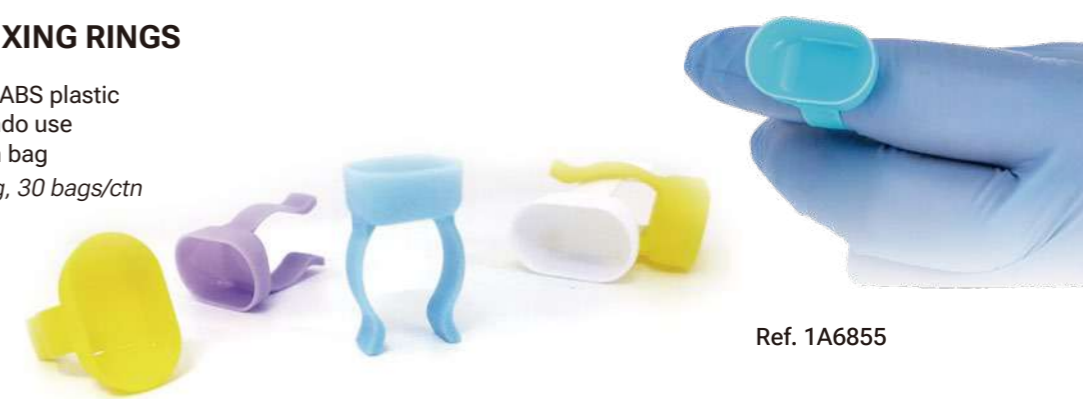

Ref. 1A6855

**PROPHY CUP Latex Free**

- Smooth and soft cup head
- High torque gear to perform, long lasting
- Will not skip or over heat

Packing: 100 pcs/box, 100 boxes/ctn

ref.#	description
1A6200	Latch type, 4 webs
1A6200-B	Latch type, 6 webs
1A6201	Screw-in type, 6 webs
1A6204	Pointed Polisher, latch type
1A6205	Pointed Polisher, screw-in type



1A6200 4 Webs



1A6200-B 6 Webs



1A6201 Screw-in



Pointed Polisher

**PROPHY BRUSH**

1A6230



1A6220



1A6225



1A6231

- Made of sturdy and soft nylon or bristle
- Provide excellent stain removal and adaptability to teeth surfaces

ref.#	description	pcs/bag	bags/ctn
1A6220	Latch, flat type	100	100
1A6225	Latch, tapered type	100	100
1A6230	Latch, cup type, nylon	100	100
1A6231	Latch, cup type, bristle	100	100

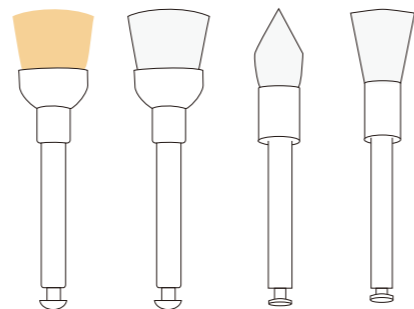

1A6231 1A6230 1A6225 1A6220

**COLORFUL PROPHY CUP AND BRUSH**

1A6200-CS



1A6230-CS



1A6220-CS

ref.#	description	pcs/bag	bags/ctn
1A6200-CS	Propphy cup, latch, mix colors or single color	100	100
1A6220-CS00	Propphy brush flat type, latch, mix colors or single color	100	100
1A6225-CS	Propphy brush tapered type, latch, mix colors or single color	100	100
1A6230-CS	Propphy brush cup type, latch, mix colors or single color	100	100



1A6225-CS

**RUTO-CLEAN MICRO PROPHY BRUSHES Latch type, single use**

- Special micro head shape for gentle and precise cleaning and polishing
- Ideal for accessing hard to reach oral area
- Suitable for use with right angle fittings

Packing: 100 pcs/box, 100 boxes/ctn



1A6227-F	Conical, firm, brush length 10 mm, top dia.2 mm, end dia.4 mm	1A6227-S	Conical, soft, brush length 10 mm, top dia.2 mm, end dia.4 mm	1A6228-F	Straight, firm, brush length 10 mm, dia.2 mm	1A6228-S	Straight, soft, brush length 10 mm, dia.2 mm	1A6229-P	Mini square with flat head, brush length 4 mm, dia.2 mm	1A6229-J	Mini square with bevel head, brush length 4 mm, dia.2 mm
----------	---	----------	---	----------	--	----------	--	----------	---	----------	--

**DISPOSABLE PROPHY ANGLES**

- Available with firm or soft cups, latex free
- Precision gears for reduced vibration and fatigue
- Unique reverse helix rib design to reduce splatter and efficiently remove stains
- Self-pouch packing

ref.#	description	pcs/bag	bags/box
1A6100-F	Firm, gray cup	100	5
1A6100-S	Soft, blue cup	100	5



### STAINLESS STEEL MOUTH MIRROR & HANDLE

- Special treatment of mirror surface offer brighter reflection than standard mirror
- Anti-heat, autoclavable

ref.#	description	pcs/box	boxes/ctn
1A6140	4#, anti-heat plain	50	30
1A6141	4#, anti-heat magnify	50	30
1A6142	5#, anti-heat plain	50	30
1A6143	5#, anti-heat magnify	50	30
1A6144	Brass mirror handle - hexagon	10	50
1A6147	Stainless steel mirror handle - round	10	50
1A6148	Stainless steel mirror handle - octagon	10	50



### DISPOSABLE MOUTH MIRROR - PC Lens

- For oral examination, high light reflection
- Disposable use, resist cross-contamination
- Sterilization pouch package, save cost
- Different colors available



1A6152-R

1A6152

ref.#	description	pcs/box	boxes/ctn
1A6152	Spatula end	300	6
1A6152-R	Round-pointed end	300	6

### WIDE-VISION MOUTH MIRROR

- Wider mirror provides clear vision
- Mirror diameter: 25 mm
- Dimension: 150 mm long
- Each mirror is individually wrapped



ref.#	description	pcs/box	boxes/ctn
1A6155-B	Blue	300	6
1A6155-G	Green	300	6
1A6155-R	Red	300	6
1A6155-O	Orange	300	6

### DISPOSABLE MOUTH MIRROR – Ruler End

- Safe plastic lens, sterile package
  - Ergonomic designed handle, skid-proof
  - Ruler end design, maximum 35 mm scale
- Packing : sterile pouch packing,  
100 pcs/bag, 30 bags/ctn

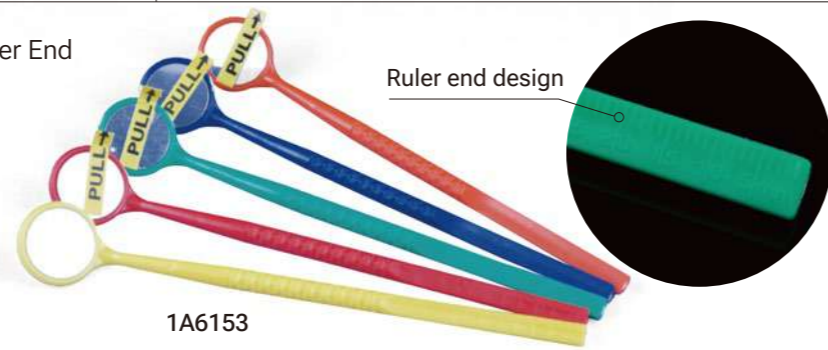

1A6153

### COLORPRO PERIODONTAL EXPLORER/PROBE

- Designed for dental examination with graduation markings on the tip
- Sterile pouch package, single use
- Come with safety plastic tube on the tip
- Non autoclavable polypropylene and stainless steel

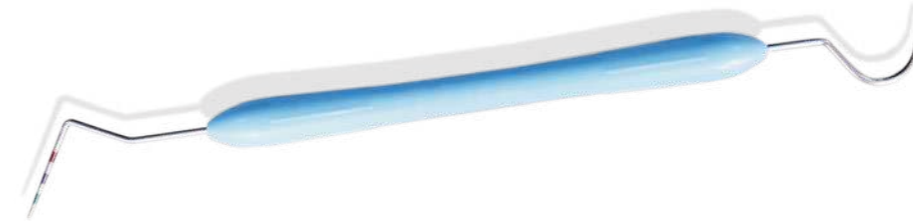

ref.#	description	pcs/box	boxes/ctn
1A6162-C	Probe with 3-color coded marking	200	6
1A6162-B	Probe with 3-black coded marking	200	6
1A6163-W	Probe with ball tip(real color, without coded marking)	200	6
1A6163-C	Probe with ball tip 3-color coded marking	200	6
1A6163-B	Probe with ball tip black color coded marking	200	6

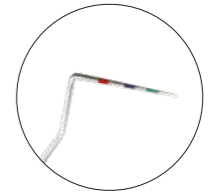

1A6162-C  
1A6162-B



1A6163-W  
1A6163-C  
1A6163-B

### DISPOSABLE DENTAL PROBE

- Sterile pouch packing, avoid cross-contamination
- Special design handle, skidproof, increase comfort
- Different colors are available

ref.#	description	packing
1A6160	Single head	400 pcs/box, 6 boxes/ctn
1A6161	Dual heads	3000 pcs/ctn
1A6164	Single head with scale tip	3000 pcs/ctn

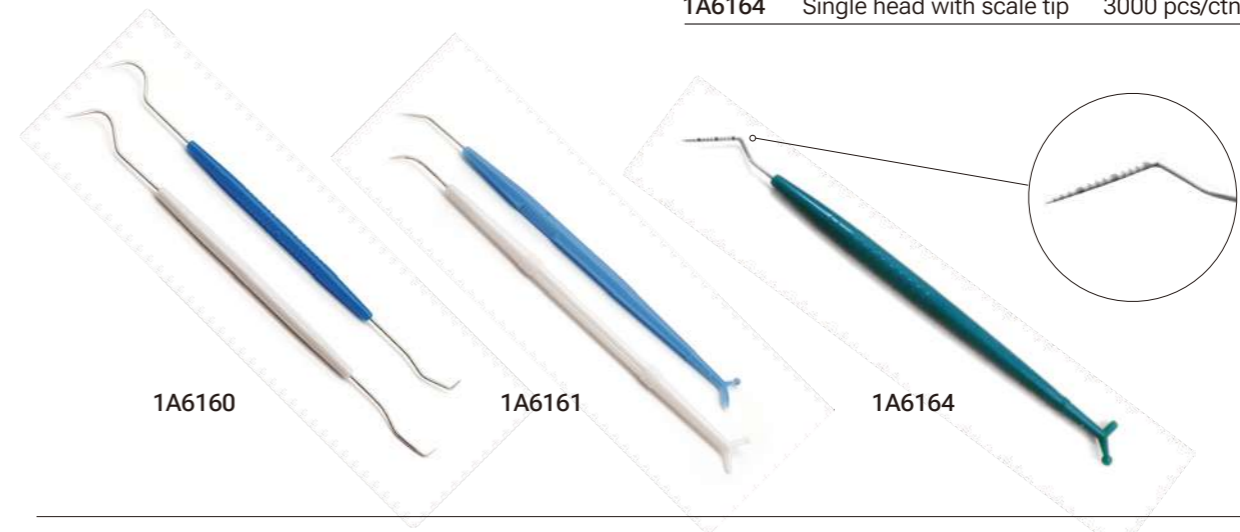

1A6160

1A6161

1A6164

### DISPOSABLE DENTAL TWEEZERS

- Non-slip ABS handle, easy handling and nice control
  - Steel with nickel coated tip, durable and non-rust
  - Sterile pouch packed, safe to use
- Packing: 150 pcs/box, 6 boxes/ctn



1A6167

### STERILE DENTAL INSTRUMENTS KIT

- Made of sturdy medical class material
- Convenient to use in a see-through sterile pouch
- Different colors/handles are available
- Sterilized by EO

ref.#	description	packing
1A6170	<b>3 in 1 Kit, includes:</b> PC lens mirror x 1, probe x 1, tweezers x 1	100 sets/box, 6 boxes/ctn
1A6173	<b>5 in 1 Kit, includes:</b> PC lens mirror x 1, probe x 1, tweezers x 1, bib x 1, tray x 1	200 sets/ctn
1A6175	<b>12 in 1 Kit, includes:</b> PC lens mirror x 1, tweezers x 1, bib x 1, drape x 1, face mask x 1, spatula x 1, probe x 2, cotton roll x 4	100 sets/ctn



3 in 1 Kit



5 in 1 Kit



12 in 1 Kit

### DISPOSABLE IRRIGATION SET

- Use for irrigation system for coolant liquids especially in implant operation.



ref.#	description	pcs/box	boxes/ctn
1A6181-BA	For Bien Air	150	6
1A6181-WH	For W&H	150	6
1A6181-NSK	For NSK	150	6
1A6181-NO	For NOUVAG	150	6

More brands are compatible upon request

### IMPLANT AND ORAL SURGERY DRAPE KIT

- Designed sterile kit, ideal for short routine procedure
- All the accessories are made of medical class material
- Easy to use, minimize the risk of cross-contamination

Custom-tailor kits are welcome.



#### ImplanAccord Ref. 1A6178

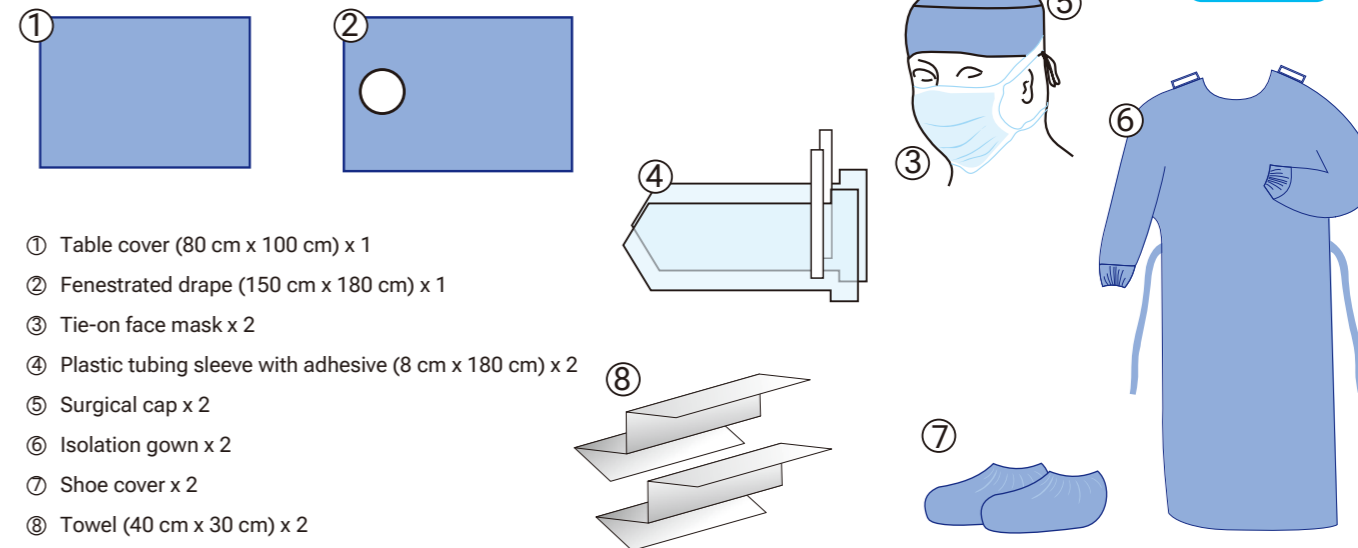

#### ImplanPlus Ref. 1A6179

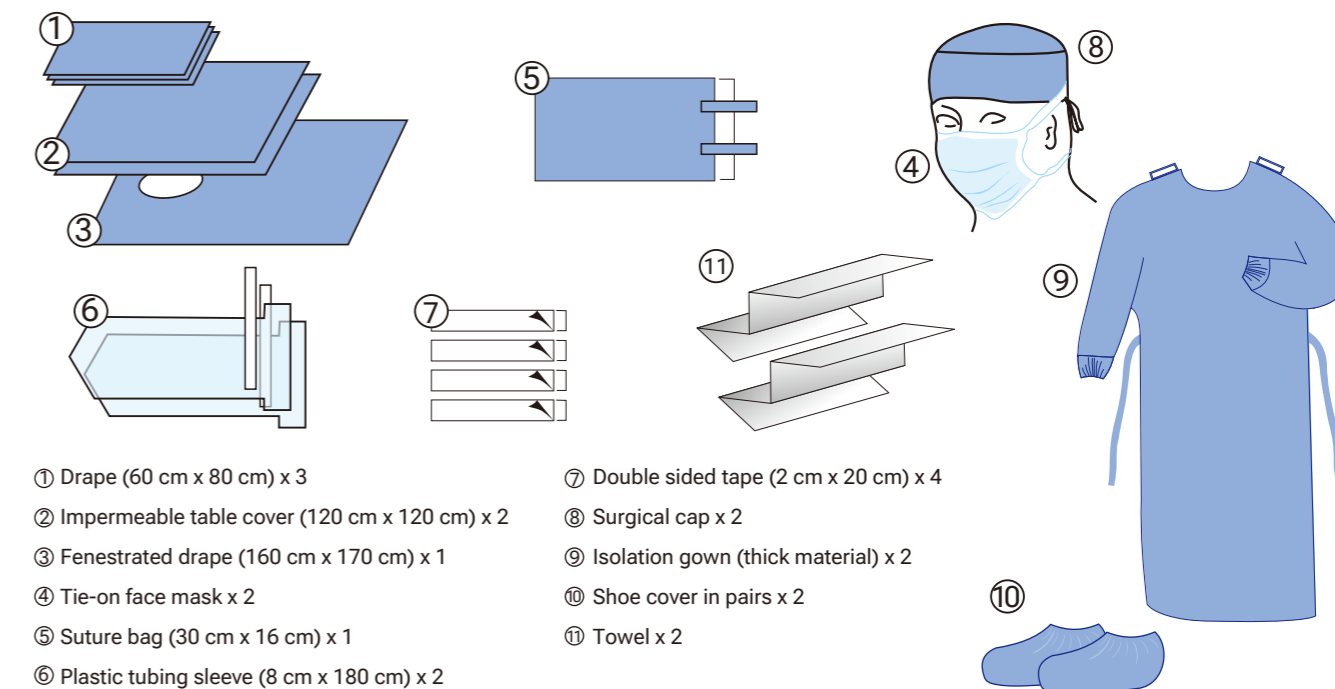

### DISPOSABLE SURGICAL BLADE

- Precision cutting edge design, ideal for multiple incisions
- Individual sterile package (by Gamma)
- Available with two materials: **Stainless Steel** and **Carbon Steel**
- Please indicate the blade size(s) when place an order

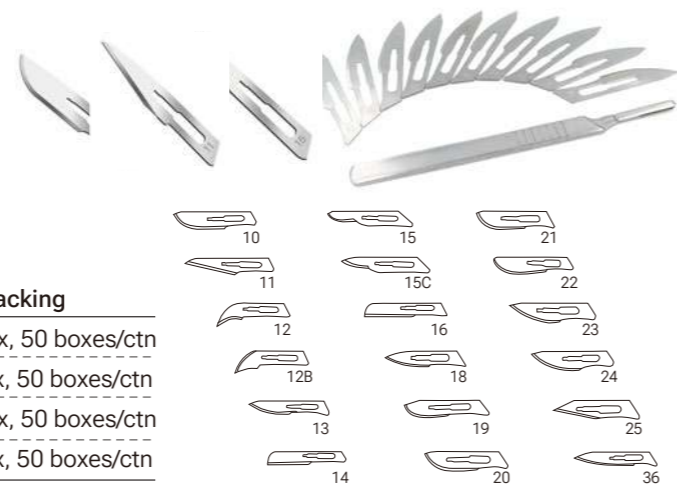

ref.#	description	packing
1A8600	Carbon steel blade	100 pcs/box, 50 boxes/ctn
1A8600-H	Carbon steel blade with handle	10 sets/box, 50 boxes/ctn
1A8601	Stainless steel blade	100 pcs/box, 50 boxes/ctn
1A8601-H	Stainless steel blade with handle	10 sets/box, 50 boxes/ctn

### STERILE SUTURE WITH NEEDLE



ref.#	description(suture material)	pcs/box	boxes/ctn
1A8610	Chromic Catgut	12	50
1A8611	Plain Catgut	12	50
1A8612	Silk (Braided)	12	50
1A8613	Nylon (Monofilament)	12	50
1A8614	Polyester (Braided)	12	50
1A8615	Polypropylene ( Monofilament)	12	50
1A8616	PGA (Polyglycolic Acid)	12	50
1A8617	PGA 910 (Polyglactin 910)	12	50
1A8618	PDO (Polydioxanone)	12	50

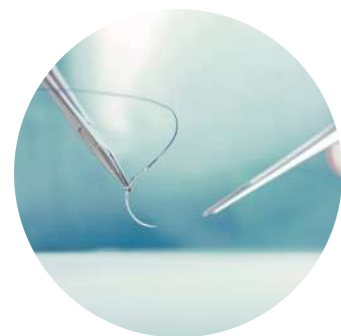

**Ultra Sharp Needle Point**  
For atraumatic tissue penetration

**Silicone-coated Stainless Steel Needle**  
Provide maximum strength and smoothness

**Drill End Press Fit**  
Offers perfect connection between thread and needle

**Tread in Any Reasonable Length**  
Available in 9 premium suture materials

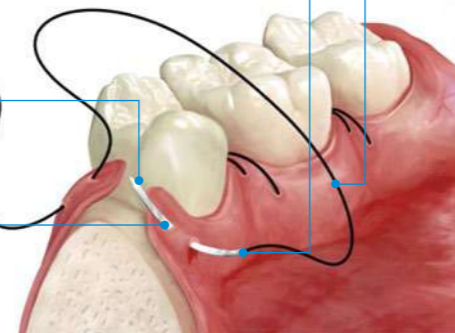

### BLACK CARBON FIBER RUBBER DAM FRAME

- Carbon fiber plastic, ultra light, autoclavable
- Ensures the strength and elasticity

ref.#	description	pc/bag
1A6731-S	Small size	1
1A6731-M	Medium size	1
1A6731-L	Large size	1
1A6731-AS	Assorted size, each x1	3

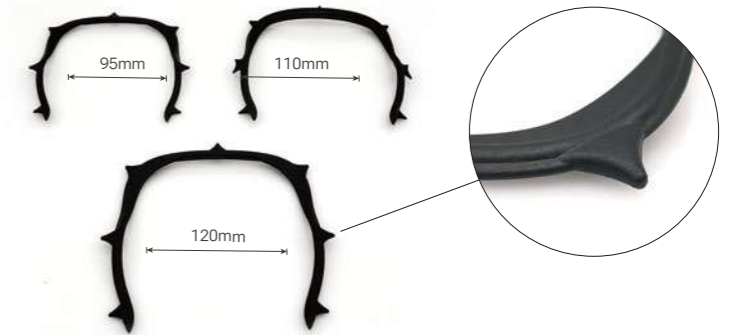

### U-STYLE PLASTIC RUBBER DAM FRAME

- Proven design with stable grips
- Enhance patient comfort
- Autoclavable

Colors: White, blue, green, purple.  
Packing: 1 pc/bag or 10 pcs/box



Ref. 1A6712

### PLASTIC RUBBER DAM FRAME Shield Type

- Arch-design offers greater curvature to ensure stability
- Tines allow for easy and secure dam attachment
- Autoclavable

Colors: Blue, white  
Packing: 5 pcs/bag



Ref. 1A6712-S

### FOLDABLE PLASTIC RUBBER DAM FRAME

- Carbon fiber material, high toughness free from deformation
- Firm construction but light
- Smooth cone tip, secure dam sheet without broken
- Foldable design for angle adjustment
- Autoclavable



Ref. 1A6712-C

Colors: Blue, green, purple, black  
Packing: 1 pc/bag

### HAND-HELD ORANGE SHIELD

- Protect dentist and assistant simultaneously from harmful UV and blue light
- Eliminates need for multiple pairs of bonding glasses
- Can be held by patient, assistant or free hand operator
- Cold disinfect only

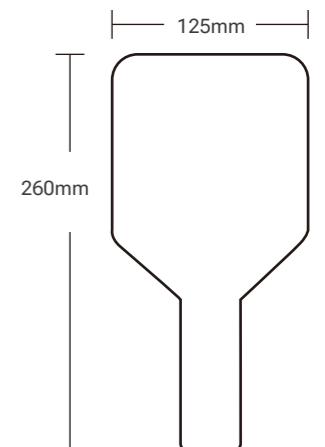

Ref. 1F0058

### DISPOSABLE DIVIDED TRAY

- Light and durable plastic, for single use
- Built-in instrument places, mixing wells, gauze slots, etc.
- Assorted colors

Packing: 400 pcs/ctn

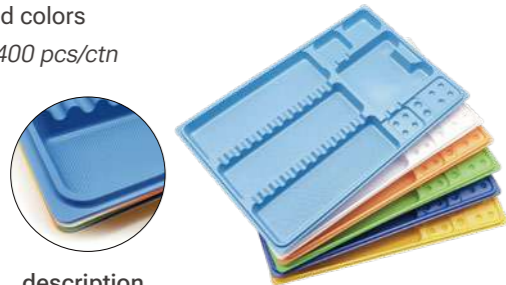

ref.#	description
1A6576	White color, standard size: 290x190x17 mm
1A6576-C	Assorted colors, standard size: 290x190x17 mm
1A6578	White color, small size: 190x150x17 mm
1A6578-C	Assorted colors, small size: 190x150x17 mm

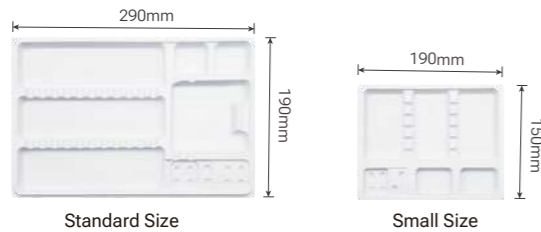

### DENTAL TRAY COVER

- Low absorbent and smooth paper
- Large rounded corner to fit the most standard flat tray
- Size: 8-1/4"x12-1/4" (215x310 mm)



ref.#	description	pcs/ctn
1A4440	White	1000
1A4443	Assorted colors	1000

### AUTOCLAVABLE PLASTIC CABINET TRAY

- Autoclavable up to 134°C
- Size: 220x110x20 mm
- Designed for convenience and efficiency
- PP material, easy to clean, disinfect and sterilize
- Colors: Blue, dark blue, white, green, pink, purple, yellow, etc.

Packing: 100 pcs/ctn

### DISPOSABLE Mini FLAT TRAY

- Disposable and light
- Small size to save space
- Assorted colors if required

Packing: 400 pcs/ctn

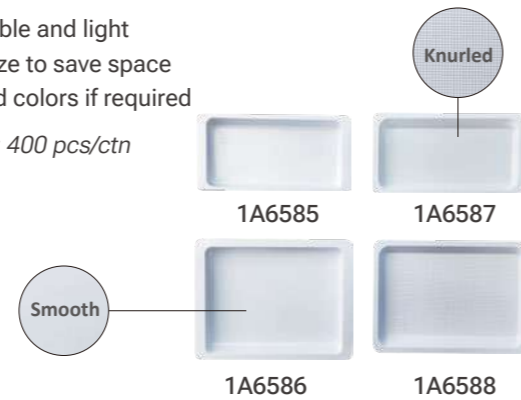

ref.#	description
1A6585	White, smooth bottom, size: 205x100x20 mm
1A6586	White, smooth bottom, size: 210x160x20 mm
1A6587	White, knurled bottom, size: 205x105x17 mm
1A6588	White, knurled bottom, size: 205x150x17 mm

### AUTOCLAVABLE PLASTIC TRAY

- Made of heavy and durable plastic
- Fully autoclavable
- Colors: Blue, dark blue, white, green, pink, purple, yellow, etc.



ref.#	description	pcs/ctn
1A6571	Flat tray, 340x250x20 mm	40
1A6571-D	Divided tray, 340x250x20 mm	40
1A6571-S	Small flat tray, 240x165x20 mm	60



### PAPER CUPS

- Made of recyclable and eco-friendly materials
- Cute teeth patterns, easy to attract attention
- Drop directly after use, save time



ref.#	description	pcs/bag	bags/ctn
1A4310	Brush My Teeth 3 OZ	50	80
1A4311	Happy Teeth 3 OZ	50	80
1A4312	Brush My Teeth 5 OZ	100	30
1A4313	Happy Teeth 5 OZ	100	30
1A4314	Brush My Teeth 7 OZ	50	40
1A4315	Happy Teeth 7 OZ	50	40

### PLASTIC CUPS

- Made of biodegradable material
- Disposable, throw away after use, without any cleaning work
- Rolled rim and the horizontal textured walls of the cups are designed for rigidity and strength, as well as for better grip
- More colors are available upon request

Packing: 100 pcs/bag, 30 bags/ctn  
50 pcs/bag, 20 bags/ctn



#### 50 Z (148 ml)

ref.#	description
1A4320-W	White, 5 OZ
1A4320-B	Blue, 5 OZ
1A4320-G	Green, 5 OZ
1A4320-P	Pink, 5 OZ
1A4320-L	Lavender, 5 OZ

#### 70 Z (199 ml)

ref.#	description
1A4340-W	White, 7 OZ
1A4340-B	Blue, 7 OZ
1A4340-G	Green, 7 OZ
1A4340-P	Pink, 7 OZ
1A4340-L	Lavender, 7 OZ

### CUP DISPENSER

- Made of ABS+ transparent PC plastic
- Paste by magnet onto metal wall or mounting to the dental chair by screw
- Securely fits 7 OZ cups

ref.#	description	pc/box	boxes/ctn
1A6866	Chair-mounted by screw	1	50
1A6867	Wall-mounted by magnet	1	30

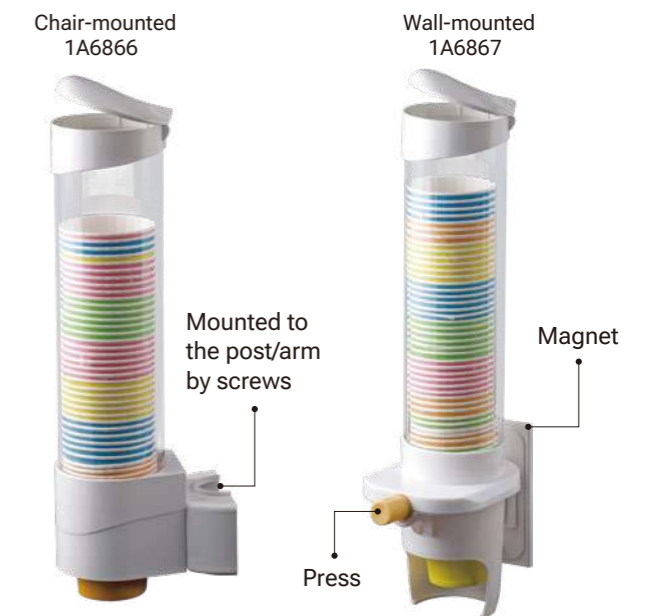

### C SHAPE MOUTH OPENER

- Strong and flexible material, self constructed
- Provides complete view for anterior and posterior teeth

ref.#	description	packing
1A6108-B	Large size	2 pcs/bag
1A6108-M	Medium size	2 pcs/bag
1A6108-S	Small size	2 pcs/bag

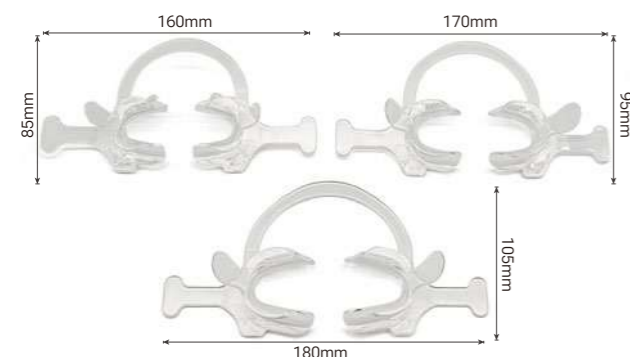

### M SHAPE CHEEK RETRACTOR

- Spring extension will retract both lips away for the operative area
- Special for bonding orthodontic braces to anterior teeth
- Helpful for placing composite restorative material

ref.#	description	packing
1A6112	Large size	20 pcs/bag OR 2 pcs/box
1A6113	Medium size	20 pcs/bag OR 2 pcs/box
1A6114	Small size	20 pcs/bag OR 2 pcs/box

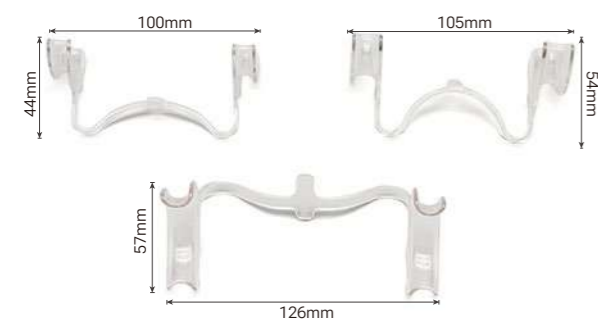

### Y SHAPE CHEEK RETRACTOR

- Smooth edge design
- Short handle for easy operation

1A6101 Large size with short handle

Packing: 20 pcs/bag



### C SHAPE CHEEK RETRACTOR

- Stretched in the vertical direction of the patient's mouth
- For the treatments of front teeth area, orthodontics, etc.

ref.#	description	packing
1A6109	Large size	20 pcs/bag OR 2 pcs/box
1A6110-M	Medium size	20 pcs/bag OR 2 pcs/box
1A6111-S	Small size	20 pcs/bag OR 2 pcs/box

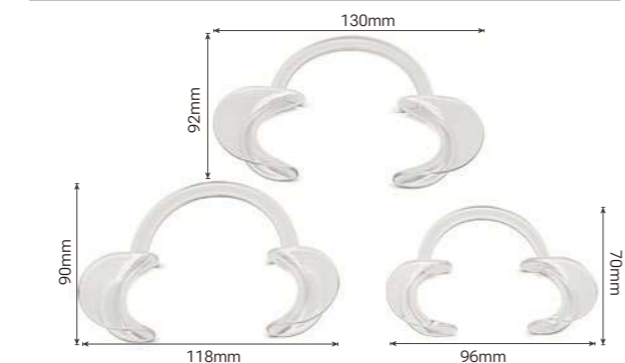

### T-PRO SHAPE CHEEK RETRACTOR

- Durable material, comfortable handling
- Gives an unobstructed view of the oral cavity

Ref.#	description	packing
1A6106-B	Large size	20 pcs/bag OR 2 pcs/box
1A6106-S	Small size	20 pcs/bag OR 2 pcs/box

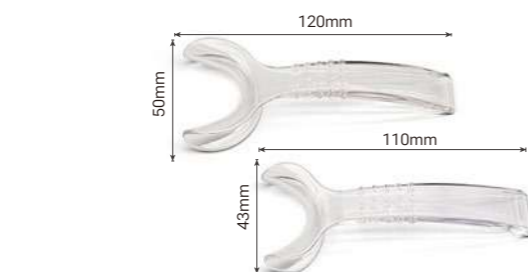

### T SHAPE CHEEK RETRACTOR

- Gives an unobstructed view of the oral cavity

ref.#	description	packing
1A6120	Large size	20 pcs/bag OR 2 pcs/box
1A6121	Small size	20 pcs/bag OR 2 pcs/box



### Y-PRO SHAPE CHEEK RETRACTOR

- Integrated molding
- Senior Heavy arch handle

1A6102 Large size with arch handle

Packing: 20 pcs/bag OR 2 pcs/box



### Y- SHAPE CHEEK RETRACTOR

Pull hook

- Luxury plastic
- Extra comfortable retractor and handle

1A6103 Large size with long & thick handle

Packing: 20 pcs/bag OR 2 pcs/box



### SHORT HOOK CHEEK RETRACTOR

- Short pull hook helps getting any oral view

1A6105 Short pull hook with arch handle

Packing: 20 pcs/bag



### MOUTH EXPANDER (EXTENDED)

Double spans

- Extended handle, double spans for more options of views.

ref.#	description	packing
1A6122	Large	20 pcs/bag
1A6123	Small	OR 2 pcs/box

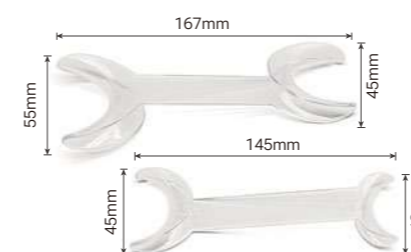

### LIP RETRACTOR

- Great anatomical fit, one size fits most
- The 45° angle bend provides wrist comfort to the clinician

ref.#	description	packing
1A6136-B	Large for adult	10 pcs/bag
1A6136-S	Small for child	10 pcs/bag

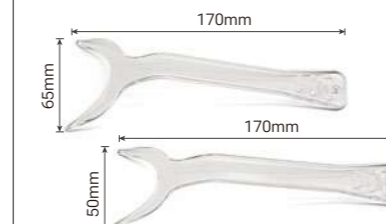

### MOUTH EXPANDER

Double spans

- Double spans for more options of views.

ref.#	description	packing
1A6107-B	Large	20 pcs/bag
1A6107-S	Small	OR 2 pcs/box

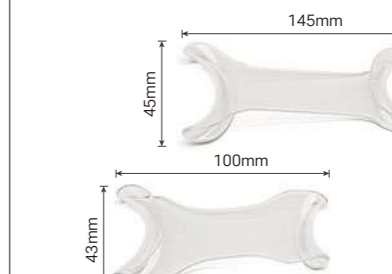

### M-SHAPE CHEEK RETRACTOR WITH MIRROR

- For most of oral operation especially whitening
- Mirror helps to see back sides of the teeth

ref.#	description	packing
1A6115-B	Blue	20 pcs/bag or 2 pcs/box
1A6115-Y	Yellow	20 pcs/bag or 2 pcs/box
1A6115-W	White	20 pcs/bag or 2 pcs/box

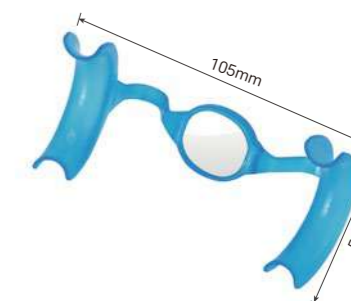

### LIP RING RETRACTOR

- Sized for adults and children
- Made of medical grade plastic
- Works well for bonding and intraoral photography

ref.#	description	pcs/bag	bags/ctn
1A6127-W	White	10	200
1A6127-B	Blue	10	200

### 3D-PLUS MOUTH OPENER

- Reusable plastic retractor
- Retracts lips and cheeks for optimal buccal and gingival access
- Suitable for all preventive, diagnostic, orthodontic, and restorative applications

Notes: Compatible with the cold sterilization or the autoclave (<121°C), take the pink tips down when autoclaving.

ref.#	description	packing
1A6134-B	Blue Color, large Size: 10.4cm x 7.4cm	1 pc/bag
1A6134-S	White Color, small Size: 9.8cm x 6.8cm	1 pc/bag



### O SHAPE SOFT COMFY CHEEK RETRACTOR

- Super soft and bendy
- Made of medical grade material
- Special for teeth whitening, cosmetic dentistry
- Regular size fits most adults, small size for kids, or adults with smaller mouths
- Colors available: blue, green and pink

ref.#	description	packing
1A6126-B	Regular size: 85mm x 60mm	1 pc/bag
1A6126-S	Small size: 80mm x 58mm	1 pc/bag



### MOUTH SUPPORT *Latex free*

- Made of durable material
- Easily avoiding patient fatigue in a long treatment



Autoclavable silicone material

ref.#	description	packing
1A6131-L	Large, lavender color	20 pcs/bag, 50 bags/ctn
1A6131-M	Medium, green color	20 pcs/bag, 50 bags/ctn
1A6131-S	Small, yellow color	20 pcs/bag, 50 bags/ctn



TPE material, non-autoclavable, only cold disinfection

ref.#	description	packing
1A6130-L	Large, green color	20 pcs/bag, 50 bags/ctn
1A6130-M	Medium, blue color	20 pcs/bag, 50 bags/ctn
1A6130-S	Small, purple color	20 pcs/bag, 50 bags/ctn



### ARTICULATING PAPER

- Smooth, soft, non-sticking, super sensitive surface for marking at every point of articulation
- The most accurate marking paper even in wet areas with little or no smudging

Packing A: 40 sheets/book, 10 books/box, 50 boxes/ctn  
 Packing B: 20 sheets/book, 10 books/box, 50 boxes/ctn  
 Packing C: 12 sheets/book, 12 books/box, 50 boxes/ctn  
 Packing D: 20 sheets/book, 6 books/box, 100 boxes/ctn  
 Packing E: 12 sheets/book, 6 books/box, 100 boxes/ctn  
 Packing F: 40 sheets/book, 6 books/box, 100 boxes/ctn



ref.#	description	feature
<b>STANDARD</b>		
Packing A	1C0458 Blue, thin, 30μ	Higher accurate
Packing B	1C0464 Red, thick, 100μ	Special newly hydrophilic pigments formula, helps to see the change of the occlude surface before and after treatment
Packing C	1C0460 Blue & red, thick, 100μ	Red and blue on each sheet, convenient for using, easy to see the change of occlusal surface before and after treatment
Packing B	1C0465 Blue, thick, 100μ	The most economic and widely used, softer and more flexible, integrated with teeth grooves to closely, reduce the possibility of misjudgment
<b>HORSE SHOE</b>		
Packing D	1C0461 Red, thick, 100μ	Easy to find the biting side of patients
Packing D	1C0462 Blue, thick, 100μ	
Packing E	1C0463 Blue & red, thick, 100μ	Blue and red on each sheet
<b>PRECISELY TRUE(Finest Quality)</b>		
STANDARD TYPE		
Packing D	1C0457 Red, thin, 30μ	Used for checking the matching degree of teeth crown with gums while wearing of fake teeth, the most accurate marking paper
HORSE SHOE TYPE		
Packing F	1C0456 Red, thin, 30μ	

### WOODEN WEDGES

- Made of natural wood
- Color coded for easy identification
- Small secure box provides easy access

Packing: 100 pcs/box



ref.#	description
1A8640	Orange, 1.3x1.5x13 mm
1A8641	White, 1.5x1.5x14 mm
1A8642	Green, 1.5x1.5x14 mm
1A8643	Yellow, 1.5x1.5x16 mm
1A8644	Blue, 1.5x2.0x14 mm
1A8645	Pink, 1.5x2.0x16 mm

### POLY WEDGES

- Specially design for easy insertion and removal
- Slightly compressible poly material provides ideal tooth separation
- Rounded tip protects gingival
- Square end ensures secure handling

Packing: 100 pcs/bucket, 60 buckets/box, 12 boxes/ctn



ref.#	description
1A6834-XS	Extra small, blue
1A6834-S	Small, green
1A6834-M	Medium, yellow
1A6834-L	Large, purple

### KNIFE TYPE WEDGE

- The combination of a plate and a plastic wedge
- The plate is made of stainless steel
- Pre-separating the teeth while prepare the tooth
- Prevents damage to the adjacent tooth and gingiva during preparations

Packing: 100 pcs/box, 100 boxes/ctn

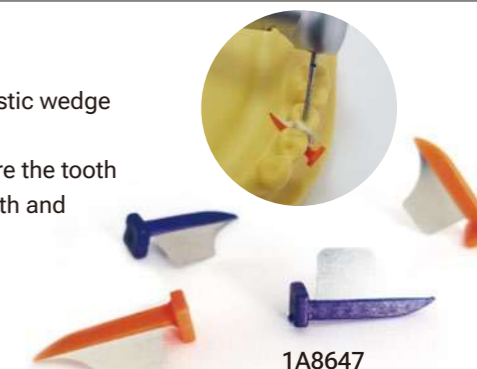

### GUTTA PERCHA POINTS



ref.#	description	pcs/box	boxes/ctn
1A2660-A	ISO Spec.: 15, 20, 25, 30, 35, 40	120	600
1A2660-B	Slide Pack (A) Square Tube Pack (B)	120	400
1A2661-A	ISO Spec.: 45, 50, 55, 60, 70, 80	120	600
1A2661-B	Slide Pack (A) Square Tube Pack (B)	120	400
1A2662-A	ISO Spec.: 90, 100, 110, 120, 130, 140 Slide Pack (A)	60	600

### ABSORBENT PAPER POINTS



ref.#	description	pcs/box	boxes/ctn
1A2680-A	ISO Spec.: 15, 20, 25, 30, 35, 40	200	600
1A2680-B	Slide Pack (A) Square Tube Pack (B)	200	400
1A2681-A	ISO Spec.: 45, 50, 55, 60, 70, 80	200	600
1A2681-B	Slide Pack (A) Square Tube Pack (B)	200	400
1A2682-A	ISO Spec.: 90, 100, 110, 120, 130, 140 Slide Pack (A)	100	600

### DoTaper GUTTA PERCHA POINTS

with Length Mark  
 Sizes available: F1, F2, F3, F4, F5.



### DoTaper PAPER POINTS

with Length Mark  
 Sizes available: F1, F2, F3, F4, F5.



ref.#	description	pcs/box
1A2691	DoTaper Gutta Percha Points single or assorted sizes packing	60
1A2696	DoTaper Paper Points single or assorted sizes packing	60

### Standardized Points (Accessory)

- Notes: all dimension to be measured to an accuracy 0.05 mm.
- A tolerance of  $\pm 0.05\text{mm}$  applies to D3, D16. Taper proportion is 0.02 mm per 1 mm at uniform taper.
- Overall length is not less than 28 mm  $\pm 0.1$  mm unless otherwise specified.

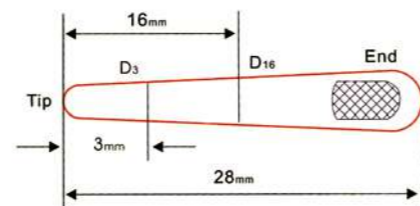

SIZE	PROJECTED DIAMETER AT THE TIP	DIA.D3 3 mm FROM TIP	DIA.D16 Tol.16 mm FROM TIP	Tol.	SIZE	PROJECTED DIAMETER AT THE TIP	DIA.D3 3 mm FROM TIP	Tol.	DIA.D3 3 mm FROM TIP	Tol.
15	0.15	0.21	0.47	$\pm 0.05$	60	0.60	0.66	$\pm 0.07$	0.92	$\pm 0.07$
20	0.20	0.26	0.52		70	0.70	0.76		1.02	
25	0.25	0.31	0.57		80	0.80	0.86		1.12	
					90	0.90	0.96		1.22	
					100	1.00	1.06		1.32	
					110	1.10	1.16		1.42	
					120	1.20	1.26		1.52	
					130	1.30	1.36		1.62	
					140	1.40	1.46		1.70	

### GREATER TAPER GUTTA PERCHA POINTS

Ideal for obturating root canals which have been prepared with GT files, profile, Quantecs etc, Greater Taper 0.04 and 0.06 are available in assorted or individual sizes, at the top of points (D1), the diameter corresponds to the ISO sizes, but then the conicity is greater than ISO points.

ref.#	description	pcs/box	boxes/ctn
1A2665	0.04 greater taper, size No. 15, 20, 25, 30, 35, 40	60	600
1A2666	0.06 greater taper, size No. 15, 20, 25, 30, 35, 40	60	600

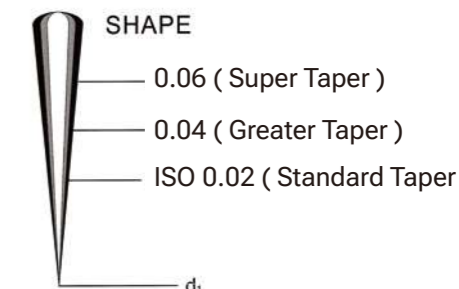

### ENDO ORGANIZER GP/PP MIXTURE



Endo Aide Organizer (C)

ref.#	description	pcs/box	boxes/ctn
1A2685	GP 15-40#, PP 15-40#	GP-120 pcs PP-200 pcs	60
1A2686	GP 15-40#, PP 15-40#	GP-240 pcs PP-400 pcs	60

### ENDO CONTAINER COMPLETE

For Endo File and GP/PP



ref.#	description	pcs/box	boxes/ctn
1A2690	Size: #15 - #100	1	100

### NON-STANDARDIZED POINTS

- Note: A tolerance of  $\pm 0.05\text{mm}$  applies to D3, D16.
- Taper proportion is variable dependent upon nominal size but is of uniform taper.
- Overall length is 28mm  $\pm 0.1$  mm unless other specifies.

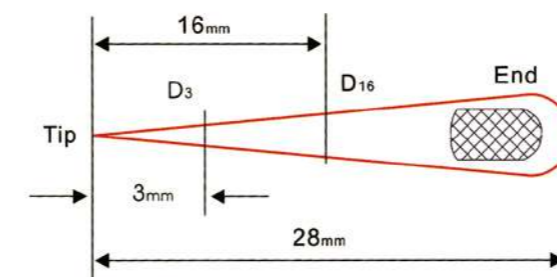

ref.#	description	Dia. D3 3mm from tip(mm)	Dia. D16 16mm from tip(mm)	pcs/box
1A2667	XF (Extra-Fine)	0.20	0.45	100
1A2668	FF (Fine-Fine)	0.24	0.56	100
1A2669	MF (Medium-Fine)	0.27	0.68	100
1A2670	F (Fine)	0.30	0.80	100
1A2671	FM (Fine-Medium)	0.35	0.88	100
1A2672	M (Medium)	0.40	1.10	100
1A2673	ML (Medium-Large)	0.43	1.25	60
1A2674	L (Large)	0.49	1.55	48
1A2675	XL (Extra-Large)	0.52	1.60	48

### NITI/STAINLESS STEEL ENDO FILE

- High flexibility, suits for complicated root canal structure
- Special cutting edge, with high cutting efficiency
- Strong resistance to wear, long usage life
- ISO Sizes: # 15-white, #20-yellow, #25-red, #30-blue, #35-green, #40-black
- Length: 21 mm, 25 mm, 28 mm, 31 mm

Packing: 6 pcs/box, available in individual or assorted sizes



**New Arrival**  
Hand-use Endo Files  
with **Scale End**



More efficient, more accurate.

ref.#	description	pcs/pkt
1A2326	Niti, single or assorted sizes packing	6
1A2327	Stainless steel, single or assorted sizes packing	6

### NITI ENDO FILE Packing: 6 pcs/box

ref.#	description (niti endo file)
1A2200	Hand use H file (ISO #15-40, length 21mm)
1A2201	Hand use H file (ISO #15-40, length 25mm)
1A2202	Hand use H file (ISO #08, length 21mm)
1A2203	Hand use H file (ISO #08, length 25mm)
1A2204	Hand use H file (ISO #10, length 21mm)
1A2205	Hand use H file (ISO #10, length 25mm)
1A2206	Hand use H file (ISO #45-80, length 21mm)
1A2207	Hand use H file (ISO #45-80, length 25mm)

ref.#	description (niti endo file)
1A2260	Hand use Spreader file (ISO #15-40, length 21mm)
1A2261	Hand use Spreader file (ISO #15-40, length 25mm)
1A2262	Hand use Spreader file (ISO #08, length 21mm)
1A2263	Hand use Spreader file (ISO #08, length 25mm)
1A2264	Hand use Spreader file (ISO #10, length 21mm)
1A2265	Hand use Spreader file (ISO #10, length 25mm)
1A2266	Hand use Spreader file (ISO #45-80, length 21mm)
1A2267	Hand use Spreader file (ISO #45-80, length 25mm)

ref.#	description (niti endo file)
1A2220	Hand use K file (ISO #15-40, length 21mm)
1A2221	Hand use K file (ISO #15-40, length 25mm)
1A2222	Hand use K file (ISO #08, length 21mm)
1A2223	Hand use K file (ISO #08, length 25mm)
1A2224	Hand use K file (ISO #10, length 21mm)
1A2225	Hand use K file (ISO #10, length 25mm)
1A2226	Hand use K file (ISO #45-80, length 21mm)
1A2227	Hand use K file (ISO #45-80, length 25mm)

ref.#	description (niti endo file)
1A2280	Hand use Plugger file (ISO #15-40, length 21mm)
1A2281	Hand use Plugger file (ISO #15-40, length 25mm)
1A2282	Hand use Plugger file (ISO #08, length 21mm)
1A2283	Hand use Plugger file (ISO #08, length 25mm)
1A2284	Hand use Plugger file (ISO #10, length 21mm)
1A2285	Hand use Plugger file (ISO #10, length 25mm)
1A2286	Hand use Plugger file (ISO #45-80, length 21mm)
1A2287	Hand use Plugger file (ISO #45-80, length 25mm)

ref.#	description (niti endo file)
1A2240	Hand use Reamer file (ISO #15-40, length 21mm)
1A2241	Hand use Reamer file (ISO #15-40, length 25mm)
1A2242	Hand use Reamer file (ISO #08, length 21mm)
1A2243	Hand use Reamer file (ISO #08, length 25mm)
1A2244	Hand use Reamer file (ISO #10, length 21mm)
1A2245	Hand use Reamer file (ISO #10, length 25mm)
1A2246	Hand use Reamer file (ISO #45-80, length 21mm)
1A2247	Hand use Reamer file (ISO #45-80, length 25mm)

ref.#	description (niti endo file)
1A2300	Engine use H file (ISO #15-40, length 21mm)
1A2301	Engine use H file (ISO #15-40, length 25mm)
1A2302	Engine use K file (ISO #15-40, length 21mm)
1A2303	Engine use K file (ISO #15-40, length 25mm)
1A2304	Engine use Reamer file (ISO #15-40, length 21mm)
1A2305	Engine use Reamer file (ISO #15-40, length 25mm)
1A2306	Engine use Plugger file (ISO #15-40, length 21mm)
1A2307	Engine use Plugger file (ISO #15-40, length 25mm)

### STAINLESS STEEL ENDO FILE Packing: 6 pcs/box

ref.#	description (stainless steel endo file)
1A2340	Hand use H file (ISO #15-40, length 21mm)
1A2341	Hand use H file (ISO #15-40, length 25mm)
1A2342	Hand use H file (ISO #08, length 21mm)
1A2343	Hand use H file (ISO #08, length 25mm)
1A2344	Hand use H file (ISO #10, length 21mm)
1A2345	Hand use H file (ISO #10, length 25mm)
1A2346	Hand use H file (ISO #45-80, length 21mm)
1A2347	Hand use H file (ISO #45-80, length 25mm)

ref.#	description (stainless steel endo file)
1A2360	Hand use K file (ISO #15-40, length 21mm)
1A2361	Hand use K file (ISO #15-40, length 25mm)
1A2362	Hand use K file (ISO #08, length 21mm)
1A2363	Hand use K file (ISO #08, length 25mm)
1A2364	Hand use K file (ISO #10, length 21mm)
1A2365	Hand use K file (ISO #10, length 25mm)
1A2366	Hand use K file (ISO #45-80, length 21mm)
1A2367	Hand use K file (ISO #45-80, length 25mm)

ref.#	description (stainless steel endo file)
1A2370	Hand use Reamer file (ISO #15-40, length 21mm)
1A2371	Hand use Reamer file (ISO #15-40, length 25mm)
1A2372	Hand use Reamer file (ISO #08, length 21mm)
1A2373	Hand use Reamer file (ISO #08, length 25mm)
1A2374	Hand use Reamer file (ISO #10, length 21mm)
1A2375	Hand use Reamer file (ISO #10, length 25mm)
1A2376	Hand use Reamer file (ISO #45-80, length 21mm)
1A2377	Hand use Reamer file (ISO #45-80, length 25mm)

ref.#	description (stainless steel endo file)
1A2390	Hand use Spreader file (ISO #15-40, length 21mm)
1A2391	Hand use Spreader file (ISO #15-40, length 25mm)
1A2392	Hand use Spreader file (ISO #08, length 21mm)
1A2393	Hand use Spreader file (ISO #08, length 25mm)
1A2394	Hand use Spreader file (ISO #10, length 21mm)
1A2395	Hand use Spreader file (ISO #10, length 25mm)
1A2396	Hand use Spreader file (ISO #45-80, length 21mm)
1A2397	Hand use Spreader file (ISO #45-80, length 25mm)

ref.#	description (stainless steel endo file)
1A2410	Hand use Plugger file (ISO #15-40, length 21mm)
1A2411	Hand use Plugger file (ISO #15-40, length 25mm)
1A2412	Hand use Plugger file (ISO #08, length 21mm)
1A2413	Hand use Plugger file (ISO #08, length 25mm)
1A2414	Hand use Plugger file (ISO #10, length 21mm)
1A2415	Hand use Plugger file (ISO #10, length 25mm)
1A2416	Hand use Plugger file (ISO #45-80, length 21mm)
1A2417	Hand use Plugger file (ISO #45-80, length 25mm)

ref.#	description (stainless steel endo file)
1A2430	Engine use H file (ISO #15-40, length 21mm)
1A2431	Engine use H file (ISO #15-40, length 25mm)
1A2432	Engine use K file (ISO #15-40, length 21mm)
1A2433	Engine use K file (ISO #15-40, length 25mm)
1A2434	Engine use Reamer file (ISO #15-40, length 21mm)
1A2435	Engine use Reamer file (ISO #15-40, length 25mm)
1A2436	Engine use Plugger file (ISO #15-40, length 21mm)
1A2437	Engine use Plugger file (ISO #15-40, length 25mm)

### HEAT ACTIVATION NITI PROTAPER FILES

- Made of high quality Niti alloy material
- Excellent flexibility, high cutting efficiency and fracture resistance
- Progressive taper design improves treatment effects, especially in tighter or more curved canals
- Recommended rotary speed: 250 - 350 r/min
- Sizes available: SX, S1, S2, F1, F2, F3, mix 6 sizes

Packing: 6 files per box, available of single or assorted sizes

ref.#	description	pcs/box
1A2324-SX	Size: SX	6
1A2324-S1	Size: S1	6
1A2324-S2	Size: S2	6
1A2324-F1	Size: F1	6
1A2324-F2	Size: F2	6
1A2324-F3	Size: F3	6
1A2324-MIX	From SX to F3	6



Ref. 1A2324



### ENGINE-USE NITI SUPER FILE

- Made of Niti material
- Perfect flexibility, long durability
- High cutting efficiency and fracture resistance
- Autoclavable with 134°C



ref.#	description	pcs/box
1A2321-SX	SX Protaper	6
1A2321-S1	S1 Protaper	6
1A2321-S2	S2 Protaper	6
1A2321-F1	F1 Protaper	6
1A2321-F2	F2 Protaper	6
1A2321-F3	Similar to F3 Protaper	6
1A2321-M	Mix of: # SX, # S1, # S2, # F1, # F2, # F3	6

### ENDO CASSETTE

- Size: 6.5 cm x 3.0 cm x 5.5 cm, 18 holes, stainless steel made
- Ideal for use in ultrasonic baths, disinfectors, vapor, cleaner, etc.
- A silicone cursor on the cover for counting the number of times used
- Inside ruler can measure the length of endo files during operation

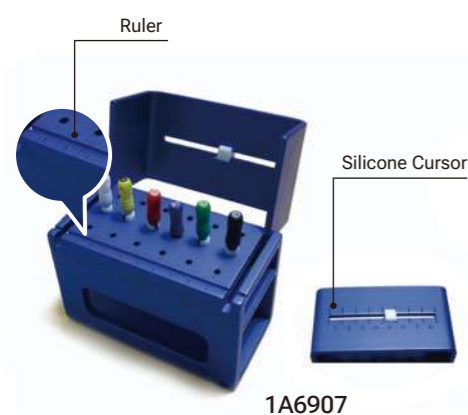

1A6907

### ENDO FOAM

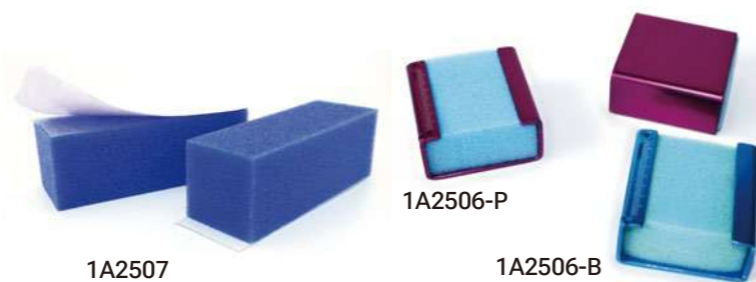

1A2507

1A2506-P

1A2506-B



1A2503 1A2505



1A2500



1A2501



1A2502

ref.#	description	pc/bag	bags/ctn
1A2500	Isosceles trapezoid	100	10
1A2501	Foam insert	48	100
1A2502	Round	48	100
1A2503	Round, blue, 65 x 8 mm	50	50
1A2505	Round, blue, 50 x 8 mm	50	50
1A2506-P	Aluminium holder with foam inside, purple		
1A2506-B	Aluminium holder with foam inside, blue		
1A2507	Peel and stick cushion, 75 x 25 x 25 mm, 50 pcs/box		

More shapes and materials are available upon requests.

### PLASTIC ENDO STAND with foam cushion and ruler



Gauge: 0 - 30 mm  
# 12 - # 27  
autoclavable

Ref. 1A9264

### SHORT BARBED BROACHES WITH HANDLE

- Made of stainless steel
- Used to remove tooth nerve and pulp tissue for root canal treatment
- The pore at the end of holder can be used to make safety chain of petiolate nerve broach, to keep from getting into trachea
- Broach autoclavable with 134°C

Length: 21 mm or 25 mm



ref.#	description	pcs/pack
1A4100	0 #, purple	10
1A4101	1 #, white	10
1A4102	2 #, yellow	10
1A4103	3 #, red	10
1A4104	4 #, blue	10
1A4105	5 #, green	10
1A4106	6 #, black	10
1A4110	0 # - 6 #, mix color	10

### PEESO REAMER / GATES DRILL

- Made of medical class stainless steel
- Good flexibility and fracture resistance
- High cutting and drilling efficiency
- Recommended rotary speed (engine use): 800 - 1,200 r.p.m.
- Autoclavable with 134°C

Length: 25 mm, 28 mm or 30 mm

Peeso Reamer

ref.	description	pcs/box
1A2440	28 mm, size # 1 - # 6	6
1A2441	32 mm, size # 1 - # 6	6

Gates Drill

ref.	description	pcs/box
1A2446	28 mm, size # 1 - # 6	6
1A2447	32 mm, size # 1 - # 6	6

### DENTAL SCREW POST



material	ref.#	pcs/set	description
Stainless Steel	1A2422-120	120	Size, available:
	1A2422-240	240	S1, S2, S3, S4, S5, S6
Gold	1A2424-120	120	M1, M2, M3,
	1A2424-240	240	M4, M5, M6
Titanium	1A2426-120	120	L1, L2, L3, L4,
	1A2426-240	240	L5, L6 XL4, XL6

Single size packing is available.



Peeso Reamer

Gates Drill

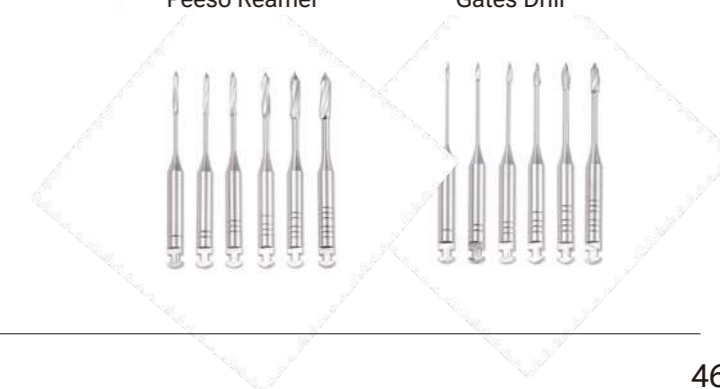

**ALUMINIUM ENDO DISINFECTION BOX**



Solid Holder



Two-layer Holder

ref. # (Solid Holder)	description	ref. # (Two-layer Holder)
1A9002-W <input type="checkbox"/>	72 FG Mes.: 105 x 45 x 50 mm	1A9002-WD <input type="checkbox"/>
1A9002-B <input checked="" type="checkbox"/>		1A9002-BD <input checked="" type="checkbox"/>
1A9002-R <input checked="" type="checkbox"/>		1A9002-RD <input checked="" type="checkbox"/>
1A9006-W <input type="checkbox"/>	36 FG + 36 Endo File Mes.: 105 x 45 x 50 mm	1A9006-WD <input type="checkbox"/>
1A9006-B <input checked="" type="checkbox"/>		1A9006-BD <input checked="" type="checkbox"/>
1A9006-R <input checked="" type="checkbox"/>		1A9006-RD <input checked="" type="checkbox"/>
1A9014-W <input type="checkbox"/>	60 hole, 30 FG + 30 Endo File + 4 tubes (GP) Mes.: 105 x 45 x 50 mm	1A9014-WD <input type="checkbox"/>
1A9014-B <input checked="" type="checkbox"/>		1A9014-BD <input checked="" type="checkbox"/>
1A9014-R <input checked="" type="checkbox"/>		1A9014-RD <input checked="" type="checkbox"/>



ref. #	description
1A9012-W <input type="checkbox"/>	35 holes for FG + Endo File + 6 Tubes (GP), with Endo Ruler Mes.: 118 x 83 x 50 mm
1A9012-B <input checked="" type="checkbox"/>	
1A9012-R <input checked="" type="checkbox"/>	

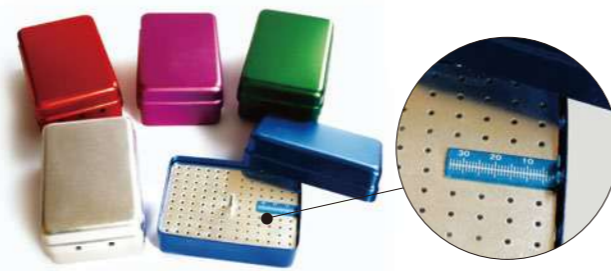

ref. #	description
1A9010-W <input type="checkbox"/>	60 FG + 60 Endo File, with Endo Ruler Mes.: 118 x 83 x 50 mm
1A9010-B <input checked="" type="checkbox"/>	
1A9010-R <input checked="" type="checkbox"/>	



Aluminium Endo Box with Lid

ref. #	description
1A9040-W <input type="checkbox"/>	For burs, GP, and other instruments Mes.: 133 x 54 x 17 mm
1A9040-B <input checked="" type="checkbox"/>	
1A9040-R <input checked="" type="checkbox"/>	



ref. #	description
1A9004-B <input checked="" type="checkbox"/>	28 holes for FG + Endo File Mes.: 55 x 40 mm
1A9004-R <input checked="" type="checkbox"/>	



Round Disinfection Box

ref. #	description
1A9100-B <input checked="" type="checkbox"/>	45 holes for FG + Endo File; Dia.: 75 mm
1A9100-Y <input checked="" type="checkbox"/>	



Scaler Tip Disinfection Box

ref. #	description
1A9011-W <input type="checkbox"/>	22 holes; Mes.: 105 x 45 x 50 mm
1A9011-B <input checked="" type="checkbox"/>	
1A9011-R <input checked="" type="checkbox"/>	



Scaler and Implant Tip Box

ref. #	description
1A9104-W <input type="checkbox"/>	6 holes; Mes.: 60 x 45 x 50 mm
1A9104-B <input checked="" type="checkbox"/>	
1A9104-R <input checked="" type="checkbox"/>	

**STAINLESS STEEL ENDO RULER**

Length: 90 mm (Gauge: 0-50 mm)



Ref. 1A9250

**STAINLESS STEEL ENDO RULER**

Finger Type

Gauge: 0 - 35 mm



Ref. 1A9252

**ALUMINUM ENDO RULER**

Finger Type

Gauge: 0 - 35 mm

■ Blue 1A9254-B    ■ Yellow 1A9254-Y



**ALUMINUM ENDO RULER**

Gauge: 0 - 35 mm

■ Blue 1A9258-B  
■ Green 1A9258-G  
■ Yellow 1A9258-Y  
■ Purple 1A9258-P





Fiber Post Full Set

# FIBER POST *All Radiopaque*



Refill Pack

## End Taper FIBER POST

Ref.#1D0060

- Surface roughness pre-treatment, excellent flexural strength
- Suitable for a variety of reaming drills



1D0060	R1	R2	R3	R4
Max Diameter	1.0 mm	1.2 mm	1.35 mm	1.5 mm
Min Diameter	0.8 mm	0.9 mm	1.0 mm	1.1 mm
Total Length	18 mm	18 mm	18 mm	18 mm

ref. #	description – End Taper			
1D0060	Full Set: 20 pcs posts + 4 pcs drills Post: R1 x 5 + R2 x 5 + R3 x 5 + R4 x 5 Drill: R1 x 1 + R2 x 1 + R3 x 1 + R4 x 1			
1D0060-R1	Refill pack, R1 x 10			
1D0060-R2	Refill pack, R2 x 10			
1D0060-R3	Refill pack, R3 x 10			
1D0060-R4	Refill pack, R4 x 10			

## Double Taper FIBER POST

Ref.#1D0070

- Double taper fits to realistic contours of the treated canals
- High resistance and durable



1D0070	R1	R2	R3	R4
Max Diameter	1.25 mm	1.4 mm	1.5 mm	1.65 mm
Min Diameter	0.8 mm	0.9 mm	1.0 mm	1.1 mm
Total Length	18 mm	18 mm	18 mm	18 mm

ref. #	description – End Taper			
1D0070	Full Set: 20 pcs posts + 4 pcs drills Post: R1 x 5 + R2 x 5 + R3 x 5 + R4 x 5 Drill: R1 x 1 + R2 x 1 + R3 x 1 + R4 x 1			
1D0070-R1	Refill pack, R1 x 10			
1D0070-R2	Refill pack, R2 x 10			
1D0070-R3	Refill pack, R3 x 10			
1D0070-R4	Refill pack, R4 x 10			

## Multi Taper FIBER POST

Ref.#1D0080

- Special multi taper design provides stronger bonding strength
- Enhanced adaption in flared canals, polymerization shrinkage



1D0080	R1	R2	R3	R4
Max Diameter	1.0 mm	1.2 mm	1.35 mm	1.5 mm
Min Diameter	0.5 mm	0.6 mm	0.8 mm	1.0 mm
Total Length	18 mm	18 mm	18 mm	18 mm

ref. #	description – Multi Taper			
1D0080	Full Set: 20 pcs posts + 4 pcs drills Post: R1 x 5 + R2 x 5 + R3 x 5 + R4 x 5 Drill: R1 x 1 + R2 x 1 + R3 x 1 + R4 x 1			
1D0080-R1	Refill pack, R1 x 10			
1D0080-R2	Refill pack, R2 x 10			
1D0080-R3	Refill pack, R3 x 10			
1D0080-R4	Refill pack, R4 x 10			

## Multi Taper with Ball Head FIBER POST

Ref.#1D0090

- Multi taper surface plus ball head improve retention values
- Low modulus of elasticity prevents the risk of root fracture



1D0090	R1	R2	R3	R4
Max Diameter	1.0 mm	1.2 mm	1.35 mm	1.5 mm
Min Diameter	0.5 mm	0.6 mm	0.8 mm	1.0 mm
Total Length	13.2 mm	13.8 mm	14.9 mm	15.9 mm

ref. #	description-Multi Taper with Ball Head			
1D0090	Full Set: 20 pcs posts + 4 pcs drills Post: R1 x 5 + R2 x 5 + R3 x 5 + R4 x 5 Drill: R1 x 1 + R2 x 1 + R3 x 1 + R4 x 1			
1D0090-R1	Refill pack, R1 x 10			
1D0090-R2	Refill pack, R2 x 10			
1D0090-R3	Refill pack, R3 x 10			
1D0090-R4	Refill pack, R4 x 10			

## MORANDI IMPRESSION TRAY

- ABS material
- Different colors for easy identification
- Flexible packing: single size, pairs, assorted sizes

ref.#	description	pcs/bag	bags/ctn
1A5801	#1 Large Upper	12	50
1A5802	#2 Large Lower	12	60
1A5803	#3 Medium Upper	12	60
1A5804	#4 Medium Lower	12	70
1A5805	#5 Small Upper	12	70
1A5806	#6 Small Lower	12	90
1A5807	#7 Up Right / Low Left	12	120
1A5808	#8 Up Left / Low Right	12	120
1A5809	#9 Anterior Upper	12	120
1A5810	#10 Anterior Lower	12	120



## MORANDI IMPRESSION TRAY

- Solid design take more easily for impression
- Three color coded size to fit any patients
- Disposable or cold disinfect

ref.#	description	pcs/bag	bags/ctn
1A5980	#1 Large upper	20	30
1A5981	#2 Large lower	20	30
1A5982	#3 Medium upper	20	30
1A5983	#4 Medium lower	20	30
1A5984	#5 Pedo small lower	20	30
1A5985	#6 Pedo small upper	20	30

## DISPOSABLE IMPRESSION TRAY

- Made of strong, rigid ABS material to ensure consistent, distortion-free impressions
- Designed system of holes and perforations to optimize flow and retention of materials
- Pre-shaped design can be easily trimmed or flame softened to adjust for custom fit
- Special designed non-slip grips offer removal more easily and cleanly
- Compatible with wide range of impression materials

ref.#	description	pcs/bag	bags/ctn
1A5950	#1 Large Upper	12	10
1A5951	#2 Large Lower	12	10
1A5952	#3 Medium Upper	12	10
1A5953	#4 Medium Lower	12	10
1A5954	#5 Small Upper	12	10
1A5955	#6 Small Lower	12	10
1A5956	#7 Up L / Low R	12	10
1A5957	#8 Up R / Low L	12	10
1A5958	#9 Anterior Upper	12	10
1A5959	#10 Anterior Lower	12	10

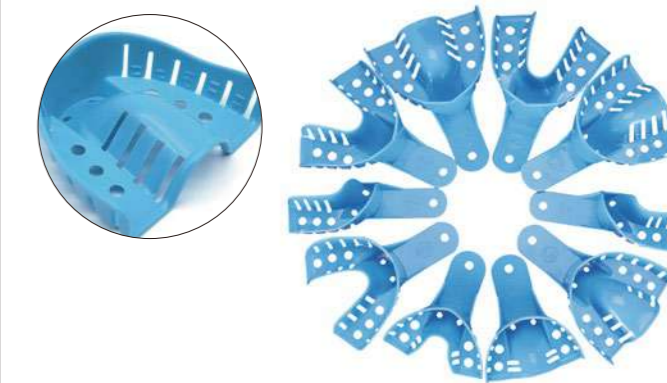

### CRYSTAL IMPRESSION TRAY

- PS material
- Special design to optimize flow and retention of materials
- Heart shape wide handle

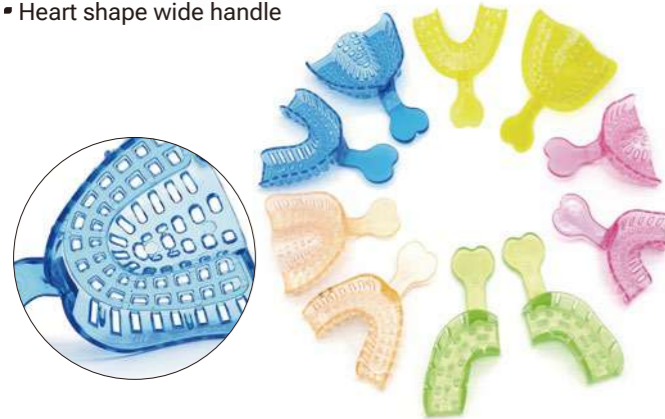

ref.#	description	pcs/bag	bags/ctn
1A5851	#1 Large Upper	12	60
1A5852	#2 Large Lower	12	60
1A5853	#3 Medium Upper	12	60
1A5854	#4 Medium Lower	12	60
1A5855	#5 Small Upper	12	60
1A5856	#6 Small Lower	12	60
1A5857	#7 Up Right / Low Left	12	60
1A5858	#8 Up Left / Low Right	12	60
1A5859	#9 Anterior Upper	12	60
1A5860	#10 Anterior Lower	12	60

### DENTAL IMPLANT IMPRESSION TRAY

- Sturdy and durable material
- Rounded and smooth edge
- Special for implant, also for mass regular procedures



Removable baffle, for easier and accurate operation.

ref.#	blue trays(autoclavable)	pcs/bag	bags/ctn
1A5871	Large pair (Upper x 1, Lower x 1)	2	100
1A5872	Medium pair (Upper x 1, Lower x 1)	2	100
1A5873	Small pair (Upper x 1, Lower x 1)	2	100
1A5874	All sizes (L x 2, M x 2, S x 2, 6 pcs)	6	30

ref.#	green trays(disposable)	pcs/bag	bags/ctn
1A5876	Large pair (Upper x 1, Lower x 1)	2	100
1A5877	Medium pair (Upper x 1, Lower x 1)	2	100
1A5878	Small pair (Upper x 1, Lower x 1)	2	100
1A5879	All sizes (L x 2, M x 2, S x 2, 6 pcs)	6	30



### GRAY IMPRESSION TRAY

- Durable material
- Unique design for high adhesion

ref.#	description	pcs/bag	bags/ctn
1A5831	#1 Large Upper	2	100
1A5832	#2 Large Lower	2	100
1A5833	#3 Medium Upper	2	100
1A5834	#4 Medium Lower	2	100
1A5835	#5 Small Upper	2	100
1A5836	#6 Small Lower	2	100

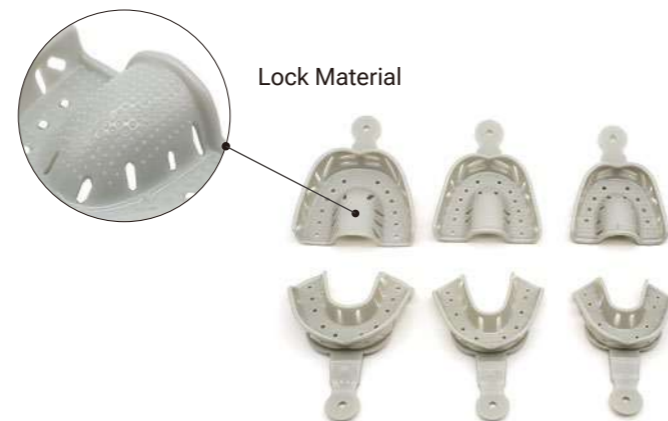

### DISPOSABLE ALGI-LOCK ORTHO IMPRESSION TRAY

- Designed extra clearance needed to fit over ortho brackets and wires without tray contact
- Alginate locks hold the impression to the tray without the use of messy adhesives
- Disposable or cold disinfect



Also suits for non-ortho patients.

ref.#	description	pcs/bag	bags/ctn
1A5970	#1 Large upper	12	60
1A5971	#2 Large lower	12	60
1A5972	#3 Medium upper	12	60
1A5973	#4 Medium lower	12	60
1A5974	#5 Pedo medium upper	12	100
1A5975	#6 Pedo medium lower	12	100
1A5976	#7 Pedo small upper	12	100
1A5977	#8 Pedo small lower	12	100

### ABS MULTI COLOR -DISPOSABLE IMPRESSION TRAY

- Made of ABS material, strong construction, cold disinfection
- Beveled perfs and retention rim-lock hold securely
- Non-slip handle with size for easy identification



### ABS COLORFUL IMPRESSION TRAY

- Made of quality ABS material, high-impact to ensure stability and accurate result without distortion, bur free
- Deliver superior performance and compatible with all impression materials

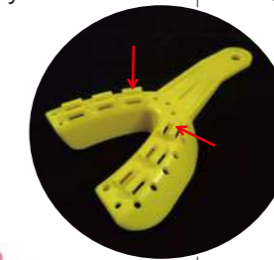

ref.#	description	pcs/bag	bags/ctn
1A5910	#1 Large Upper	12	50
1A5911	#2 Large Lower	12	50
1A5912	#3 Medium Upper	12	50
1A5913	#4 Medium Lower	12	50
1A5914	#5 Small Upper	12	50
1A5915	#6 Small Lower	12	50
1A5916	#7 Up Right / Low Left	12	100
1A5917	#8 Up Left / Low Right	12	100
1A5918	#9 Anterior	12	100

ref.#	description	pcs/bag	bags/ctn
1A5988	#1 Extra Small Upper	12	100
1A5989	#1 Extra Small Lower	12	100
1A5990	#2 Small Upper	12	60
1A5991	#2 Small Lower	12	60
1A5992	#3 Medium Small Upper	12	60
1A5993	#3 Medium Small Lower	12	60
1A5994	#4 Medium Upper	12	100
1A5995	#4 Medium Lower	12	100
1A5996	#5 Large Medium Upper	12	60
1A5997	#5 Large Medium Lower	12	60
1A5998	#6 Large Upper	12	60
1A5999	#6 Large Lower	12	60



### DISPOSABLE BITE REGISTRATION TRAY

#### 3-IN-1 TRAY

- Compatible with a wide range of impression materials
- Firm frame and durable nylon mesh for additional retention
- Smooth edge and thumb tab

ref.#	description	pcs/box	boxes/ctn
1A5931-C	#1 Posterior / Small half	50	20
1A5932-C	#2 Quadrant / Large half	35	20
1A5933-C	#3 Sideless / Extra small half	50	20
1A5930-C	#4 Anterior / Small full	35	20
1A5934-C	#5 Full Arch / Large full	30	20
1A5931	#11 Posterior / Small half	50	20
1A5932	#12 Quadrant / Large half	35	20
1A5933	#13 Sideless / Extra small half	50	20
1A5930	#14 Anterior / Small full	35	20
1A5934	#15 Full Arch / Large full	30	20



### DISPOSABLE FLUORIDE FOAM TRAY

- Designed to offer a natural contoured fit
- Exceptional comfort
- Buckle ridges for fluoride's easy access to teeth
- Color-coded, available in **Dual** and **Single** Arch



ref.#	description	pcs/bag	bags/ctn
1A5940	Dual arch, large size	50	50
1A5941	Dual arch, medium size	50	60
1A5940	Dual arch, small size	50	80

ref.#	description	pcs/bag	bags/ctn
1A5943	Single arch, large size	100	70
1A5944	Single arch, medium size	100	90
1A5945	Single arch, small size	100	110

#### Dual Arch



Large Medium Small

#### Single



Large Medium Small

### SPATULA

- Assorted colors available
- Comfort to use in any type



ref.#	description	pcs/bag	bags/ctn
1A6665	Flat handle, L195 mm	1	500
1A6666	Thumb-comfort handle, L195 mm	1	500
1A6669	Knife type, L195 mm	1	500
1A6668	Mini type, double ends, L115 mm	200	20

### NON-STICKY MIXING BOWL

- Flexible TPE material
- Washable for repeated use
- Transparent or colorful



ref.#	description(Transparent Color)	pcs/bag	bags/ctn
1A6800	4 sizes per set: S, M, L, XL	1 set	300
1A6801	XL, H65 x D65 mm	10	50
1A6802	L, H50 x D40 mm	10	50
1A6804	M, H31 x D25 mm	20	25
1A6805	S, H26 x D22 mm	30	50

Order notice: please indicate specific color if you need.

### STANDARD MIXING BOWL



ref.#	description(TPE Material)	pcs/ctn
1A6755-ES	Extra small, D88 x H55 mm	150
1A6755-S	Small, D100 x H58 mm	150
1A6755-M	Medium, D112 x H58 mm	150
1A6755-L	Large, D120 x H70 mm	100
1A6755-XL	Extra large, D130 x H82 mm	100
1A6755-XXL	Extra large and tall, D130 x H95 mm	80

### MIXING BOWL WITH LID

Double Mouth



ref.#	description	pcs/bag	bags/ctn
1A6803-L	Large, D55 x H60 mm	1	200
1A6803-S	Small, D32 x H37 mm	1	200

Order notice: please indicate specific color if you need.

### VIVID MIXING BOWL



ref.#	description(TPE Material, assorted colors)	pcs/ctn
1A6755-B	Extra-large, blue, D160 x H155 mm	50
1A6755-P	Large, pink, D148 x H110 mm	100
1A6755-Y	Medium, yellow, D130 x H85 mm	120
1A6755-G	Small, green, D115 x H70 mm	150



### GLASS MIXING PAD

Size: 124mm x 78mm x 7mm



Ref. 1A9356

### PAPER MIXING PAD



ref.#	description	sheets/pad	pads/ctn
1C0481	3" x 3" (75 x 75 mm)	100	114
1C0482	3" x 6" (75 x 150 mm)	100	90

### CAPSULE DISPENSER GUN

- Easier for placing favorite composite resins, cements, glass ionomers and impression materials by right leverage feature
  - Designed friction-lock barrel allows for easy loading of all standard material capsules
- Packing: 1 pc/bag, 160 bags/ctn



Ref. 1A6682

### CAPSULE WITH CAP

- 1 set including:  
1 capsule + 1 black cap + 1 white cap

Packing: 100 sets/bag



Ref. 1A6683

### ACTIVATOR / APPLIER

- Professional design for all of 3M material capsules and GC material capsules
- Pre-activates and dispense the capsule rapidly
- Autoclavable and easy to clean

ref.#	description	pcs/ctn
1A6810	Applier	20
1A6811	Activator	20



1A6811 Activator



1A6810 Applier

### DENTAL IMPRESSION MATERIAL GUN

- Ideal for precise silicone and epoxy resin applications
- Achieve flawless mixing and dispensing
- Easy to load and clean

ref.#	description	Packing
1A6849	1:1 / 1:2	1 pc/box, 20 boxes/ctn
1A6849-B	1:4 / 1:10	

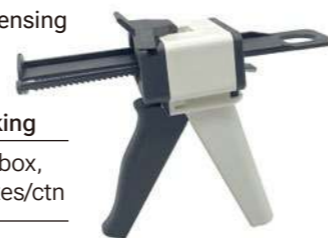

### AMALGAM CARRIER

- Injection molded from a self-lubricating high-tech durable plastic
  - Excellent for use with composites, glass ionomers and alloys
- Packing: 100 pcs/bag, 10 bags/ctn



Ref. 1A6681

### BARRIER ENVELOPS

- Designed with soft material, with rounded edge and corner
- Top sealing after phosphor plate inserts for protection
- Quick tear-off open after using
- Fully disposable envelopes, prevents cross contamination
- Available in different sizes and packing ways



#### BE1-TOP MID OPEN



ref.#	description	pcs/box	boxes/ctn
1A6650-BE1	Size 0, 25 x 38 mm	500	50
1A6651-BE1	Size 1, 27 x 43 mm	500	50
1A6652-BE1	Size 2, 33 x 46 mm	500	50
1A6653-BE1	Size 3, 30 x 57 mm	500	50
1A6654-BE1	Size 4, 57 x 76 mm	200	50

#### BE3-SIDE MID OPEN



ref.#	description	pcs/box	boxes/ctn
1A6650-BE3	Size 0, 37 x 27 mm	300	50
1A6651-BE3	Size 1, 43 x 27 mm	300	50
1A6652-BE3	Size 2, 46 x 34 mm	300	50
1A6653-BE3	Size 3, 57 x 30 mm	300	50
1A6654-BE3	Size 4, 76 x 57 mm	200	50

#### BE4-TOP SIDE OPEN



ref.#	description	pcs/box	boxes/ctn
1A6650-BE4	Size 0, 25 x 38 mm	500	50
1A6651-BE4	Size 1, 27 x 44 mm	500	50
1A6652-BE4	Size 2, 34 x 46 mm	500	50
1A6653-BE4	Size 3, 30 x 57 mm	500	50
1A6654-BE4	Size 4, 57 x 76 mm	200	50

### PROTECTIVE COVER PAPER

- Reduce cross-infection
- Keep the phosphor plate clean
- Disposable, easy to use

Packing: 100 pcs/box, 200 boxes/ctn



ref.#	description
1A6659-Z0#	Size 0, 22 x 36 mm
1A6659-Z1#	Size 1, 24 x 40 mm
1A6659-Z2#	Size 2, 30 x 41 mm

### INTRAORAL DIGITAL IMAGING PLATE



ref.#	description
1A6649-0	#0, 22 x 35 mm
1A6649-1	#1, 24 x 41 mm
1A6649-2	#2, 31 x 41 mm
1A6649-3	#3, 27 x 54 mm
1A6649-4	#4, 56 x 75 mm

### X-RAY FILM (E - SPEED)

- Higher sensitization, definition and shorter photo shoot than standard dental film, protect doctor from X-ray harm
  - With lead piece inside the film, prevent X-ray penetrate reduce the hurt to patient
  - Marked with convex point on the lip-cheek side, to distinguish the left from the right one
- Packing: 150 pcs/box, 50 boxes/ctn



ref.#	description
1A6646	ES-58 Adult film, 30 mm x 40 mm
1A6647	ES-54 Child film, 22 mm x 35 mm

### X-RAY FILM HOLDERS (PLASTIC)

- 2 workings ends: Straight/flat end, and 45° angled/bent end
- Autoclavable, wired sensors

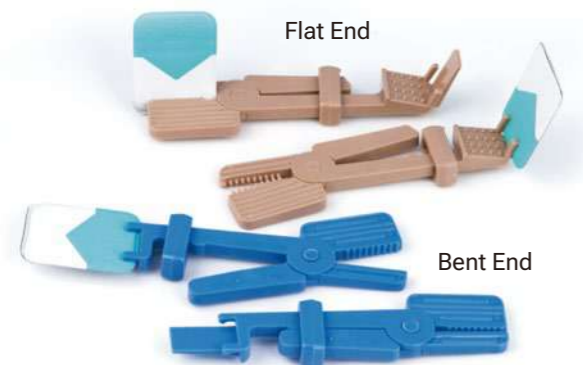

ref.#	description	pcs/box	boxes/ctn
1A6630	Reusable, straight ends	3	200
1A6631	Reusable, 45°ends	3	200

### X-RAY FILM PLASTIC MOUNTS (Clip - On)

- Easy to use, clear see through, snap on for tight fit

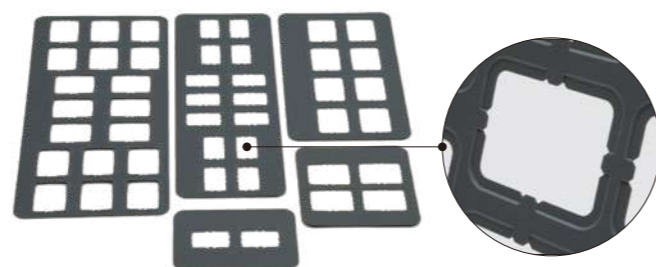

ref.#	description	pcs/box	boxes/ctn
1A6610	2 slots - Pediatric	100	10
1A6611	4 slots - Adult	100	10
1A6612	6 slots - Adult	100	10
1A6613	8 slots	100	10
1A6614	10 slots	100	10
1A6615	14 slots - Pediatric	100	10
1A6616	18 slots - Adult	100	10

### X-RAY FILM HOLDERS(METAL)



ref.#	description	set/box	sets/case or flexible
1A6660	1 clip - 1 pc	1	100
1A6661	4 clips - 2 pcs	1	100
1A6662	6 clips - 3 pcs	1	100
1A6663	8 clips - 4 pcs	1	100
1A6664	10 clips - 5 pcs	1	100
1A6676	12 clips - 6 pairs	1	100
1A6677	14 clips - 7 pairs	1	100

### X-RAY FILM HOLDING SYSTEM

- Fully color-coded, and light weight for comfort & easy assembly
  - Special bite shape with same-arch biting for a more closed bite
  - Can be used for anterior, posterior, bite & endodontic procedures
- Packing: 10 sets/ctn



ref. 1A6638

### CONFIT FILM HOLDING SYSTEM

- Designed for patient comfort and practitioner
- easy-of-use for dental radiography
- Take perfect anterior, posterior, bite wing and endodontic X-rays



Ref. 1A6639

Packing: 50 sets/ctn

### RAYFIT DIGITAL SENSOR HOLDER

- Match the X-ray cone, protecting patients from cone cutting
- Quick and easy to assemble
- Suits for all intraoral X-ray units
- Patients comfort with rounded bite blocks with no sharp edges hurt
- Steam autoclavable



Ref. 1A6639-B

Packing: 50 sets/ctn

### X-RAY LEAD APRON

ref.#	description	pcs/ctn
1F0026	Lead vest apron, size: 60 cm x 100 cm, 0.35 mmPb, cover front only	5
1F0027	Lead vest apron, size: 60 cm x 100 cm, 0.35 mmPb, cover front only	5
1F0500	Lead apron, size: 60 cm x 90 cm, 0.30 mmPb	5
1F0501	Lead apron, size: 60 cm x 90 cm, 0.5 mmPb	5
1F0503	Lead apron with collar for children, size: 48 cm x 70 cm, 0.30 mmPb	9
1F0502	Lead collar, 0.30 mmPb	50



Ref. 1F0026  
(Cover front ONLY)

Ref. 1F0027  
(Cover front ONLY)



1F0502

1F0500

1F0501

1F0503

**DAS-LID DENTURE AND RETAINER BOX**

- Medical grade PP
- Tight locking closure, for hygienic storage



ref.#	description
1A6779	Size: L82 x W85 x <b>H28</b> mm
1A6779-V	Size: L82 x W85 x <b>H28</b> mm (Cover with vents)
2A6779	Size: L82 x W85 x <b>H45</b> mm

Colors: *Blue, green, pink, white, yellow, purple, etc.*  
Packing: 12 pcs/box, 20 boxes/ctn

**VENT-LID RETAINER BOX**

- Special designed for retainers and partial denture
- The holes on the box keep it well ventilated and the oral appliance dry, clean and free from collecting odor



ref.#	description	ref.#	description
1A6780	Green	1A6783	Pink
1A6781	Red	1A6784	Yellow
1A6782	Purple	1A6785	Blue

Packing: 12 pcs/box, 20 boxes/ctn

**Translucent RETAINER BOX**

- Special designed for retainers and partial denture
- Translucent for easier vision
- Cartoon prints are available (Cartoon prints)



ref.#	description
3A6779	Plain color
3A6779-CT	Cartoon print

Colors: *Blue, green, pink, white, yellow.*  
Packing: 12 pcs/box, 20 boxes/ctn

**TOP-OPEN DENTURE BOX**

- For retainer, mouth guard, and denture case, etc.
- Both for storage and cleaning



ref.#	description	ref.#	description
1A6769	Green	2A6769	Green
1A6770	Pink	2A6770	Pink
1A6771	Blue	2A6771	Blue
1A6772	Yellow	2A6772	Yellow
1A6773	White	2A6773	White

Size: L95 x W75 x **H56** mm  
Packing: 12 pcs/box, 10 boxes/ctn

Size: L95 x W75 x **H38** mm  
Packing: 12 pcs/box, 10 boxes/ctn

**DISMAN SMOOTH DENTURE BOX**

- Popular for various kinds of dentures
- Light weight with smooth surface

ref.#	description
1A6764	Assorted colors
1A6764-S	Single color

Colors: *Blue, green, pink, white, yellow, etc.*

Packing: 16 pcs/bag, 12 bags/ctn

**DISTINCT DENTURE BOX mini**

- Special designed for retainers and mouth guard
- Small size for easy keeping

ref.#	description
1A6789	White
1A6790	Blue
1A6791	Pink
1A6792	Yellow
1A6793	Green

Packing: 12 pcs/box, 20 boxes/ctn

**TriArch DENTURE BATH BOX with basket**

- Durable and convenient.
- Can store or clean dentures
- Colors: *Blue, green, pink, white, yellow*



Ref.1A6775

Packing: 1 pc/bag, 100 bags/ctn

**Apple DENTURE BATH BOX**

- Unique and cute shape for denture cleaning and storage
- Protect dentures from squeezing and pressing in the case
- The basket makes it more convenient to drop the excessive liquid
- Colors: *Blue, green, pink, white, yellow*



Ref.1A6756

Packing: 1 pc/bag, 100 bags/ctn

**L-Handle DENTURE BATH CASE**

- Large container, applicable for all dentures and retainers
- Good for cleaning and keeping dentures and accessories
- Colors: *Blue, green, pink, white*



Ref.1A6767

Packing: 1 pc/bag, 100 bags/ctn

**PREMIUM DENTURE BATH CASE**

- Easy-to-use package for soaking and storing one full set of denture
- Designed lift-out drain cup, keep fingers out of cleaning solution
- Leak-resistant seal
- Colors: *Blue, green, purple*



Rinsing Basket, easy to filter liquid and clean the dentures.

Packing: 1 pc/bag, 100 bags/ctn

**C-shape DENTURE BOX WITH BASKET**

- Mini style, easy to operate
- A good tool for cleaning and keeping dentures
- Colors: *Blue, green, pink, white, purple*



Ref.1A6774

Packing: 1 pc/bag, 100 bags/ctn



**Ortho-love RETAINER BOX**

- Designed especially for ortho brace and retainer
- Protects inside items from squeezing and pressing
- Unique and cute shape, press to open
- Colors: Blue, green, pink, white, black, orange, purple, etc.



Ref.1A6762

Packing: 1 pc/bag, 200 bags/ctn

**Square DENTURE/RETAINER BOX WITH MIRROR**

- Large space for storage
- Light and smooth switch
- Leaky basket for easy cleaning dentures
- Size: L85 x W83 x H66 mm
- Colors: Blue, green, purple

Packing: 8 pcs/bag, 24 bags/ctn



Ref.1A6766

**VIP DENTURE BOX-TRAVEL KIT**

- Denture storage case with lockable design
- Portable and convenient to use and carry
- With mirror and cleaning brush, ideal for both home and travel
- Size: L120 x W80 x H40 mm
- Color: Grey



Ref.1A6799

Packing: 1 pc/box, 40 boxes/ctn

**BABY TOOTH BOX**

- Keeping deciduous baby teeth
- Corrosion-resistant and durable box with assorted colors
- Make children smile all the way as a gift



ref.#	description	packing
1A6796	Normal type, with necklace	50 pcs/bag
1A6796-M	Mouse type, big ears	25 pcs/bag
1A6796-MN	Mini Mouse type	50 pcs/bag

**ROUND DENTURE/RETAINER BOX WITH MIRROR**

- Ideal box for keeping retainers, braces, aligners, etc.
- Compact lock design, avoid the box from accidentally opening
- Equipped with a mirror to facilitate the wearing of teeth.
- Colors: Blue, green, pink, white, yellow, black

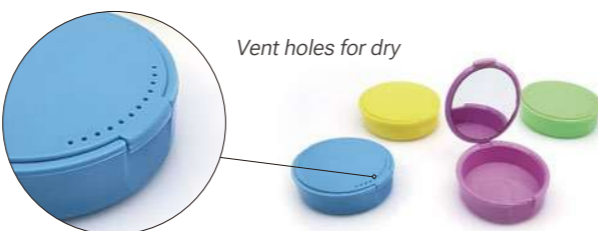

Ref.1A6788-S Small size



Ref.1A6788-L Large size

ref.#	description
1A6788-S	Small Size: 72 x 80 x H25 mm
1A6788-L	Large Size: 80 x 80 x H33 mm

Packing: 1 pc/bag, 200 bags/ctn

**PLASTIC BUR HOLDER with cover-24 holes**

- Material: medical class ABS
- Holes: 24FG
- Size: L74 x W60 x H36 mm
- Colors: Blue, green, pink, white, yellow

Ref. 1A6696

Packing: 1 pc/box, 200 boxes/ctn

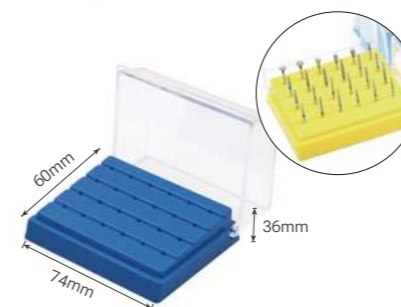
**PLASTIC BUR HOLDER with flat cover – 168 holes**

- Material: medical class ABS
- Size: L150 x W105 x H54 mm
- Colors: Beige

Ref. 1A6697 168 holes(24FG + 142RA)

Packing: 1 pc/box, 50 boxes/ctn

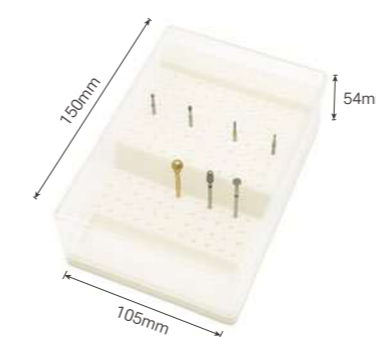
**PLASTIC PC BUR BLOCK**

- Made of PC material
- Fully autoclavable design

Packing: 200 pcs/ctn



ref.#	description
1A6906-B	12 FG, blue
1A6906-W	12 FG, white
1A6906-Y	12 FG, yellow

**PLASTIC BUR HOLDER with cover and drawer – 142 holes**

- Material: medical class plastic
- Size: L148 x W125 x H115 mm
- Colors: Beige

Ref. 1A6698 142 holes(55FG + 87RA), with drawer

Packing: 1 pc/box, 40 boxes/ctn

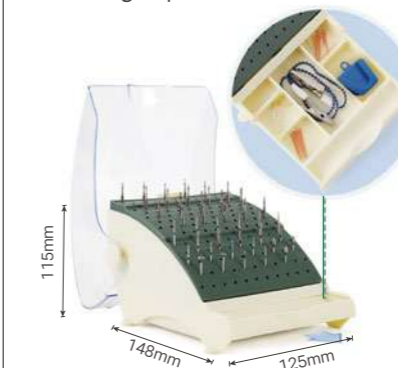
**PLASTIC BUR HOLDER with arch cover – 60 holes**

- Material: medical class PC
- Size: L90 x W60 x H35 mm
- Colors: Black, white, pink

Ref. 1A6693 60 holes(25FG + 35RA)

Packing: 1 pc/box, 200 boxes/ctn

**PLASTIC ROUND Bur Box – 48 holes**

Special for HP burs, cutters and brushes

- Material: medical class ABS
- With a transparent acrylic dust cover
- 48 holes: for RA and HP, extra height special for HP
- Size: Dia. 79 x H91 mm

Ref. 1A6692-G Green 1A6692-P Pink  
1A6692-W White 1A6692-O Orange

Packing: 1 pc/box, 72 boxes/ctn

**PLASTIC ROUND BUR BOX – 60 holes** Good for FG, RA and HP burs

- Material: medical class PP
- With a transparent acrylic dust cover
- 60 Holes: 10 FG + 20 RA + 30 HP

Packing: 1 pc/box, 40 boxes/ctn

Dia. 89 mm, height 66 mm    Dia. 89 mm, height 91 mm

1A6695L-B Blue    1A6695T-B Blue

1A6695L-P Pink    1A6695T-P Pink

1A6695L-W White    1A6695T-W White

1A6695L-Y Yellow    1A6695T-Y Yellow



1A6695L

1A6695T



### MULTIFUNCTIONAL STORAGE & DISINFECTION BOX

- Material: medical class PC
- Box includes burs and endo instruments: 25 FG + 24 RA + 3 HP + 44 Endo + 1 square pan
- Size: L135 x W108 x H65 mm

Ref. 1A6703-B Blue 1A6703-W White

Packing: 1 pc/box, 72 boxes/ctn

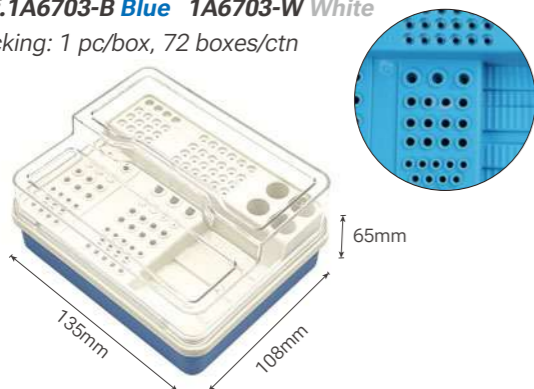

### PLASTIC DISINFECTION BOX WITH COVER AND STRAINER

- Material: medical class PC
- Light weight and compact size, easy to carry Unique design, with a leaky layer to be easily dried
- Resistant to high temperature disinfection

Ref. 1A6705-W White 1A6705-P Purple

1A6705-B Blue 1A6705-B Black

Packing: 1 pc/box, 100 boxes/ctn

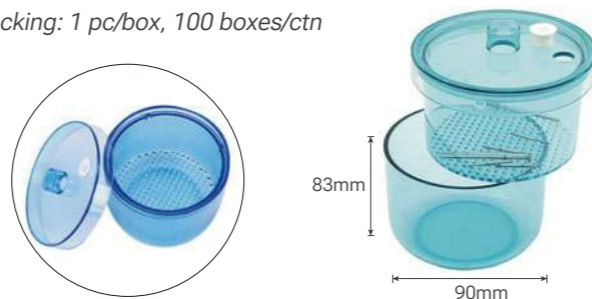

### PLASTIC BUR BLOCK with cover

- Material: medical class PA
- Size: L72 x W27 x H32 mm
- Colors: Blue, purple, black

Ref. 1A6696-18 18FG 1A6696-30 30FG

Packing: 1 pc/bag, 200 bags/ctn



### METAL BUR BLOCK

- Hinged lid snaps into place and keeps burs secure during ultrasonic cleaning and autoclaving
- Remains burs tidy all the way from tray set-up to final sterilization
- Fully autoclavable

Packing: flexible



ref.#	description
1A6900	Premium, 15 FG
1A6909	Premium, 10 FG + 5 RA
1A6904	Premium, 18 FG + 9 RA



ref.#	description
1A6911	Economic, 10 FG
1A6912	Economic, 10 RA
1A6913	Economic, 15 FG
1A6914	Economic, 10 FG + 5 RA

### MAGNETIC BUR HOLDER

- Quickly attach burs and prophylaxis cups/brushes
- Can be easily placed with its round flat bottom
- Diameter: 5.5 cm, Height: 4.5 cm



- 1A7051-B
- 1A7051-R
- 1A7051-BL



### Pla-secure INSTRUMENT STERILIZATION CASSETTE

- Made of medical grade PA material, autoclave at 135°C
- Ideal for instruments storage, management, sterilization
- Available for 4 kinds of types: 3 slots, 5 slots, 7 slots and 10 slots
- Colors available: Blue, green, purple, Yellow, black

ref.#	description
1A9112-3	3 slots, size: 210x68x25 mm
1A9112-5	5 slots, size: 210x84x25 mm
1A9112-7	7 slots, size: 210x108x25 mm
1A9112-10	10 slots, size: 210x137x25 mm

Packing: 1 pc/bag or 1 pc/box



### Stainless Steel INSTRUMENT STERILIZATION CASSETTE

- Manufactured from stainless steel, with medical grade silicone racks
- Fully autoclave at 135°C and reusable
- Highly polished finish for aesthetic and corrosion resistance
- Fits most dental instruments for sterilization and storage
- Available slots: 5 slots, 10 slots, 20 slots

Packing: 1 pc/box

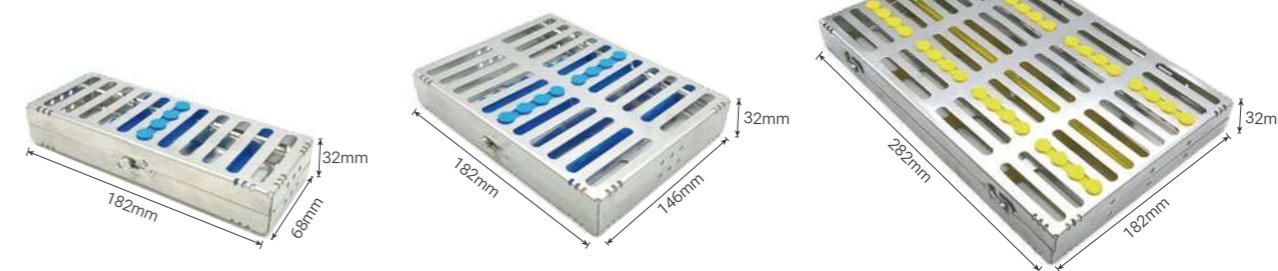

### Plas-lock INSTRUMENT STERILIZATION CASSETTE

- Made of medical grade plastic, autoclave at 135°C
- Foldable design, ideal for instruments storage, management, sterilization
- Available for 2 kinds of types: 4 slots, 8 slots
- Colors available: Blue, green, purple, Yellow, black

ref.#	description
1A9114-4	4 slots, size: 203x63x28 mm
1A9114-8	8 slots, size: 203x115x28 mm

Packing: 1 pc/bag or 1 pc/box



ref.#	description
1A9106-5	5 slots, size: 182x68x32 mm
1A9106-10	10 slots, size: 182x146x32 mm
1A9106-20	20 slots, size: 282x182x32 mm



### ORTHODONTIC SUPPLIES



LIGATURE TIES



POWER CHAINS



### ORTHODONTIC STRAIGHT TEETH SYSTEM

- Made of medical silicone for ultimate comfort
  - Simple and effective for straightening teeth
  - Wear the brace several hours each day
  - Colors available: Blue and Transparent
  - Packed with a retainer for each piece of brace
- Packing: 10 pcs/box, 60 boxes/ctn



### ORTHODONTIC BRACKETS



Ref.1A6006

### ORTHODONTIC ALIGNER CHEWIE/SEATER

- Made of edible silicone
- Firm cylinder shape helps seat aligner more smoothly and quickly
- Can be cleaned with soap and water, or diluted mouth wash
- Sealed package ensures clean and anaerobic chews, unscented.
- Size: dia.10 mm x L30 mm
- Colors by random: White, pink, green, purple, yellow, blue.

Packing: 2 pcs/box



Ref.1A6688

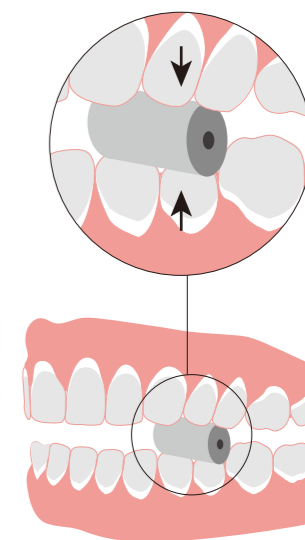

### ORTHODONTIC ALIGNER REMOVER

- Made with food grade materials
- Wide Compatibility with all Clear Aligner Brands including Invisalign, Smile Direct Club, Candid Co, and Byte, etc.
- Prevents Germs & Viruses from getting in mouth with hands-free ergonomic handle.
- Colors by random: Blue, pink, purple, white, green, etc.

Packing: 1 pc/bag, 2000 bags/ctn



Ref.1A6686



### ORTHODONTIC ELASTIC PLACER

- Designed to help fit and remove elastic bands on braces.
- Colors by random: White, pink, green, purple, yellow, blue

Packing: 100 pcs/bag, 200 bags/ctn



Ref.1A6556-1A6559

### HANDLE MIRROR – ROUND SHAPE

- Colors : white.

Packing: 1 pc/bag, 200 bags/ctn

Ref.1A9401



### HANDLE MIRROR – TOOTH SHAPE

- Colors by random: Blue, green, pink, white, yellow, purple, black.

Packing: 1 pc/bag, 200 bags/ctn



Ref.1A9400

### PREMIUM HANDLE MIRROR

- Colors: Blue, purple, orange, etc.

Packing: 1 pc/bag, 100 bags/ctn

Ref.1A9402





### ORTHO STUDY MODEL FORMER

- Models are without the hassle and mess of trimming
- Glossy inner surface makes separation easy and speeds clean-up
- Built-in lingual contoured edge with gap for tray and handle clearance
- Thicker walls maintain their shapes during vibration



ref.#	description	pcs/box	boxes/ctn
1A6722	Large, Upper	6	30
1A6723	Medium, Upper	6	30
1A6724	Small, Upper	6	30
1A6725	Large, Lower	6	30
1A6726	Medium, Lower	6	30
1A6727	Small, Lower	6	30
1A6722-M	Full sizes packing: LU x 1, MU x 1, SU x 1, LL x 1, ML x 1, SL x 1	6	30

### DISPOSABLE PLASTIC MODEL



Ref. 1A6005

Packing: 25 pcs/bag,  
40 bags/ctn

### PLASTIC ARTICULATOR (ABS)

Ref. 1A6003

Packing: 20 pcs/box,  
20 boxes/ctn



### ALCOHOL BLOW LAMP (Plastic)

Ref. 1A6719

Packing: 1 pc/box



### LAB TURNOVER BOX

- Durable and convenient
  - Mini style and easy to carry out
  - For storing or cleaning dentures
  - Size: 17cm x 13cm x 6.5cm
  - Assorted colors
- Packing: 80 pcs/ctn



1A6730

### ARTICULATOR



ref.#	description	pcs/ctn
1A6001	ABS material, black	2000
1A6000	ABS material, assorted color	2000

### ALCOHOL LAMP (Glass)

Ref. 1A6718

Packing: 1 pc/box



Thank you for being one of our most valued customers!